

# Healthy Horses, Clean Water

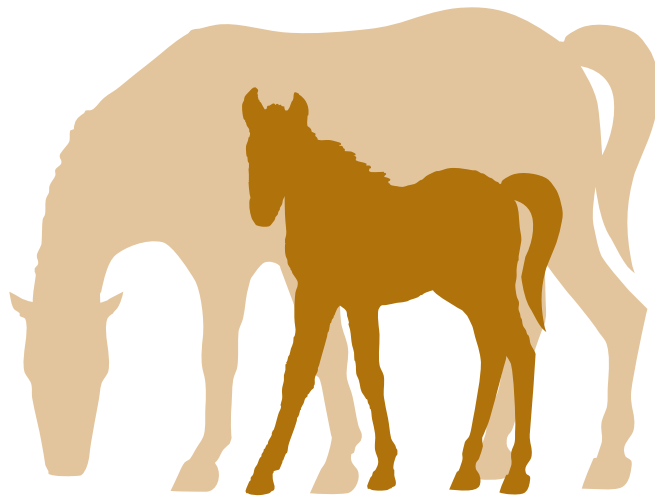

## **HORSES**<sup>®</sup> *for clean water*

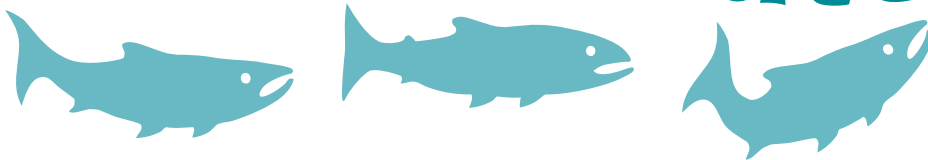

**A Guide to  
Environmentally Friendly Horsekeeping  
for Whatcom County Horse Owners**

# Healthy Horses, Clean Water

## A Guide to Environmentally Friendly Horsekeeping

Alayne Renee Blickle, Program Director, Author, Photographer, Horses for Clean Water

Jessica Paige, Environmental Consultant, Editor, Researcher, Author

Elizabeth Clark, Publication & Web Designer, Wild Horse Multimedia

Produced through funding from CCWF/DOE and administered by the Port of Bellingham.

## Acknowledgments

An advisory committee provided important assistance and review of this manual.

Special thanks is extended to:

Karin Van Vlack, Puget Sound Water Quality Action Team

Bobbi Lindemulder, Snohomish Conservation District

Marty Chaney, Natural Resources Conservation Service

Dean Hyden, Skagit Conservation District

Mike Hackett, WSU Cooperative Extension Skagit County

Andrea Hood, Whatcom Conservation District

Laurie Clinton, King County Department of Natural Resources

Program partners for this project include: Whatcom Conservation District, Skagit Conservation District, WSU Cooperative Extension Skagit County, WSU Cooperative Extension Whatcom County, the WACD Plant Materials Center, Snohomish Conservation District, King County Department of Natural Resources Livestock Programs, Northwest Horse Source and the Whatcom Chapter of the Backcountry Horsemen. Thank you for your support of environmentally sensitive horsekeeping practices.

What is Horses for Clean Water? Horses for Clean Water is a program developed *by* horse owners *for* horse owners. Our mission is to help other horse owners manage their land in the best way possible for horse health *and* the environment.

This manual is designed for non-commercial horse operations in Whatcom Counties.

For more information on Horses for Clean Water and education schedules call 425-432-6116 or check out the website at: <http://www.horsesforcleanwater.com>.

Join Horses for Clean Water and other horse folks for some good, clean horse'n around!



Content Copyright ©2003

Alayne Renée Blickle and Horses for Clean Water

Design and Layout Copyright ©2003

Elizabeth Clark and Wild Horse Multimedia

Reproduction of this manual is prohibited except by permission.

# Table of Contents



**Introduction ..... V**

**Manure Management..... 1**



**Mud Management ..... 17**

**Pasture Management ..... 23**



**Stream & Wetland Management.. 39**

**“Wild-Land” Management ..... 45**



**Your Horses and the Law ..... 53**

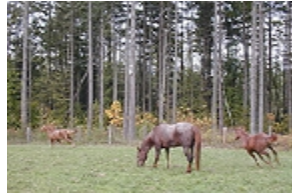

**Resources ..... 57**



**Index ..... 67**



# Introduction

## Horse Farms Can Benefit Us All

Horse properties provide valuable natural areas, a dwindling resource in the rapidly growing Puget Sound region. Open spaces like pastures, wetlands, and wooded lots prevent flooding and water pollution by absorbing and filtering rainwater. These areas also provide much-needed habitat for wildlife. Horse owners generally have a strong interest in environmental protection and go to great lengths to protect and expand trails and open spaces. Horse operations are also an important part of the Northwest's economy and provide a valuable economic service to a wide variety of businesses throughout the area.

### *What is Land Management?*

How you manage the grass in your pastures, deal with mud in confinement areas, and dispose of stall waste are a few examples of land management on a horse property. Good land management protects horse health and water quality. A horse property that is managed well can also prevent disputes with neighbors, attract wildlife, and make horse care more enjoyable.

### *The Economic Value of Good Land Management*

Improving your land management doesn't need to be costly; often a slight change in operations can make a big difference and lead to long-run savings. For example, if you eliminate mud on your property, you eliminate the horse health problems associated with mud **and** the vet bills they incur. A more productive pasture can reduce feed bills. Composting manure can eliminate disposal costs. Better pest management can reduce repairs around the barn. And all of these improvements combined can increase your property value.

### *Horses and the Law*

The recent listing of Chinook salmon and bull trout as threatened species under the federal Endangered Species Act is just one indication that our lands and waterbodies need greater care and attention. Land management techniques of livestock owners play an important role in protecting these resources. King County has passed a Livestock Ordinance to support the raising and keeping of livestock in an environmentally sound manner that protects salmon habitat and water quality. Other cities and counties in our region are likely to follow their example or are in the process of creating similar ordinances. Many of the same land management practices outlined in King County's Livestock Ordinance are described in this manual. See the Resources section at the end of this manual for contacts who can provide you with more information on local livestock ordinances and other laws affecting horse properties in your county.

## How Horses Affect Our Water

When it rains, water that does not evaporate or soak into the soil runs downhill, eventually draining into a stream, lake, or wetland. This water, or “runoff,” picks up the pollutants in its path as it travels. If this water happens to be traveling across a poorly managed horse property, it’s likely to pick up nutrients and sediments from exposed soil and manure. Pollutants on the ground can also soak through the soil and pollute groundwater. Listed below are some potential pollutants typically found at a horse place:

- **Nutrients** There’s no question that the nutrients in manure are great for plants. This is a good thing in a garden or on pastures, but the same nutrients that help plants grow on land also encourage the growth of algae and other aquatic weeds in water. As these weeds grow, they can shade out and kill other aquatic vegetation beneath the water’s surface. As aquatic plants and algae decompose, they create unpleasant odors and surface scum and use up the oxygen in the water that fish and other aquatic life need. Salmon and trout are particularly at risk because they need high levels of oxygen to live.
- **Nitrate** Nitrate forms from the nitrogen in manure and can be harmful to humans when consumed at high levels. When nitrate soaks down through the soil, it can end up contaminating groundwater, the source of drinking water for many people, especially those in rural areas. Excessive amounts of nitrate in drinking water can cause health problems such as blue baby syndrome and may be linked to cancer and birth defects. Recent samplings of wells in northern Whatcom County have found nitrate levels above the U.S. Environmental Protection Agency’s safe drinking water standards.
- **Sediment** Most people realize that rainwater plus exposed soils equals mud. What many people don’t realize, however, is that this combination can also lead to water pollution. Sediment (often originating as topsoil, sand, and clay) may seem harmless enough but it poses serious problems in the water. Excess sediment turns stream and lake water cloudy, making it less suitable for fish and other aquatic life as well as for recreation. Sediment can be especially harmful in fish-bearing streams where it can smother trout and salmon eggs, destroy habitat for insects (a food source for fish), and cover prime spawning areas.
- **Bacteria** Horse manure may contain bacteria, viruses, and parasites that can contaminate nearby drinking water sources. High bacteria levels in the water can also cause gastro-intestinal disorders and other medical problems for swimmers. Fecal coliform bacteria—found in the feces of animals, including humans—is commonly used to measure possible contamination of water from human or animal waste. The coliform bacteria may not necessarily produce disease, but can indicate the presence of other bacteria, which may cause infections, hepatitis, typhoid fever and other illnesses. When coliform bacteria is found in the water around shellfish growing areas, it can lead to shellfish bed closures.

The good news is that the same land management techniques that reduce pollutants in waterbodies will also protect horse health, make your property more attractive, and save you money.

### *How to Use This Manual*

This manual is divided into the following sections:

- Manure Management
- Mud Management
- Pasture Management
- Stream and Wetland Management
- Wild-Land Management
- Your Horses and the Law
- Resources

Each section starts with a description of the issue and is followed by steps you can take to improve your horse property and reduce water pollution. A list of helpful telephone numbers, web sites, and other reference material is provided at the end of the manual in the Resources section.



# *Manure Management*



## **The Benefits of Good Manure Management**

Managing manure—pick up, storage, and disposal—is an issue for every horse property owner. A good manure management system benefits horse health and the environment as well as the general aesthetics of your property. A regular, convenient manure pick-up system will go a long way in preventing mud and worm reinfestation in your horses. An effective storage system prevents manure piles from turning into a soggy mess that can result in mud and water pollution. And a good disposal system can turn manure into an asset instead of an expensive hassle, eyesore, odor problem, and fly magnet.



## What You Can Do

### ✓ *Clean Up Manure Every One to Three Days*

Since some species of worm eggs can hatch in manure as frequently as every three days, keeping manure out of a horse's living space will help prevent reinfestation after deworming. Removing manure is also one of the best things you can do to prevent mud. Manure is great at holding moisture; by removing it you'll reduce a prime source of mud. Mud is not only unattractive and inconvenient, it's also a breeding ground for insects and diseases like abscesses, scratches, rain scald, and thrush. Preventing mud and manure build-up also helps water quality—the less mud and manure that rainwater flows through on its way to the nearest waterbody, the fewer pollutants it will carry with it.

### ✓ *Reduce Stall Waste Generated*

One horse produces 40-50 pounds of manure per day and 8 to 12 gallons of urine each day. Add bedding to that and you've got a lot of horse waste. By reducing the amount of bedding you use you'll save money by purchasing and disposing of less bedding and you'll also have a manure pile that composts faster as a result (we'll talk about why later on). Here are a few things you can do to reduce your stall waste:

- **Simply use less bedding** Horses don't need the same kind of fluffy bed we sleep in at home—just enough to soak up urine and moisture. You'll also go through a lot less bedding if stall cleaning is done carefully; try to remove only soiled bedding when cleaning stalls.
- **Put rubber mats in stalls to provide cushioning** As a result, you'll use a lot less bedding and the initial investment will produce long-run savings. Using rubber mats will also: prevent horses from ingesting dirt or sand when eating off the stall floor; make stall cleaning easier; decrease dust; prevent a pawing horse from digging holes in the stall; and provide an even surface for horses to stand on (uneven stall surfaces may cause or exacerbate leg problems).
- **Try a new type of bedding** There are some alternative bedding products on the market like newspaper bedding and wood pellets that are more absorbent than shavings. As a result, you'll end up using far less bedding (and storage space), have less to dispose of, and less to buy. These products also may create less dust, reduce odors, and compost better than shavings. Besides all the other advantages, newspaper bedding is also a great way to recycle (only clean, overstock newspaper is used and all inks are soy-based so they don't rub off on hair or harm horses).

*For more information, see the Resources section for information on suppliers of alternative bedding products.*



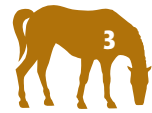

### ✓ *Cover Your Manure Pile & Choose Your Location Carefully*

- **High and dry** Covering your manure pile and placing it on a high, dry, level area away from slopes prevents manure and the area around it from turning into a muddy mess. A dry, level area is especially important when it comes to accessing the pile with any kind of heavy equipment (a tractor, truck, etc.). Equipment needs dry, level ground (preferably cement or gravel) for turning around and positioning. Choosing a location for your manure pile that's convenient to your stall and paddock areas will make the chore of cleaning up easier and less time consuming.



- **Cover and buffer** Keeping your manure covered also keeps nutrients from being washed out of the pile and into waterbodies or soaking through the soil into groundwater. There are several ways to cover your manure pile, from a simple pinned-down tarp to a storage area with a roof and concrete floor. A healthy buffer strip of grass or other vegetation downslope from your manure pile also helps filter any nutrients that wash out.



- **Keep away from waterbodies** In general, you'll want to store manure as far away as possible from streams, ditches, wetlands or other waterbodies to avoid mud problems and pollution. The exact buffer zones required between your manure pile and nearby water sources and residences will vary depending on where you live. Contact the Whatcom Conservation District or Natural Resources Conservation Service for more information.

*For more contact information, see the Resources section.*





## Composting Horse Manure & Stall Waste

### *What Is Composting?*

All organic matter (like manure and bedding) eventually decomposes. Composting just speeds up the process by providing an ideal environment for bacteria and other microorganisms that assist with decomposition. Finished compost is a crumbly, earthy-smelling, dark material that looks like a commercial potting-soil mixture. How fast your stall waste will compost depends on the size of your pile, the amount and type of bedding it contains, your method of composting, and how well you maintain it. On average, a well-managed pile can be composted in one or two months in the summer and three to five months in winter.

### *The Benefits of Composting*

Composting, as opposed to simply stockpiling your manure, has several benefits. Composting:

- Reduces flies by eliminating their breeding ground and killing larvae.
- Reduces odors—a manure pile that is composting will smell warm and earthy.
- Kills worm eggs, pathogens that can cause disease, and weed seeds.
- Reduces the pile you started with by about 50 percent! For example, if you start with a six-foot high pile, you can end up with about three feet of compost.
- Provides you with a valuable soil amendment to use on your own property, give away, or sell to others.

### *Composting Essentials*

The microorganisms that make composting happen need the same kinds of things we need: food, oxygen, and water. However, their food happens to come in the form of nitrogen and carbon—typically manure and bedding at a horse barn.

- **Nitrogen and carbon** Your pile will compost a lot faster if you've got the right carbon to nitrogen ratio. Manure, on its own, is about the perfect ratio. The more bedding you have mixed in with the manure, the more you offset this ratio and the longer the pile will take to compost. Basically, the less bedding you use and put in your pile, the faster your pile is likely to compost. If you want to speed up the process, adding materials with a high nitrogen content as you build your compost pile can help balance out the difference. Some examples of materials that are good sources of nitrogen include grass clippings, bloodmeal, chicken manure, urea, or nitrogen fertilizer. A nitrogen fertilizer will be labeled with a number like 21:0:0—These numbers represent the nitrogen:phosphorous:potassium content of the product.



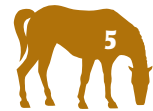

- **Oxygen** The microorganisms (or bugs, to keep it simple) in your pile need oxygen to breathe while breaking down the material. That's why it's essential for air to reach all areas of the pile—how you do this will depend on the composting method you use. As the bugs break material down, a tremendous amount of heat is given off, creating an ideal environment for the bugs to live in. These bugs thrive in temperatures between 110 and 150 degrees. At 130 degrees or higher, pathogens (organisms such as bacteria, viruses, fungi, and protozoa that are capable of producing an infection or disease), weed seeds, and fly larvae are destroyed. At least several days of pile temperatures above 130 degrees are recommended to destroy pathogens and weed seeds. But you don't want temperatures to go above 160 degrees—that's too hot for the bugs and they won't be able to survive. You can buy a long-stemmed compost thermometer at local nurseries or home and garden stores to monitor your compost piles. If your compost pile smells bad, it probably means you're not getting enough air into the pile or that the pile is too wet.
- **Water** Compost should stay about as damp as a wrung-out sponge, damp but not dripping. It's best to cover your compost pile so that you can regulate the amount of water in it—a waterlogged pile can kill the bugs and it's easier to add moisture than it is to remove it. This means that you'll probably have to add water in the summer. If you plan on turning your compost pile, you can water it down with a garden hose when you're turning it. Otherwise, you can water down wheelbarrow loads before adding them to the pile.

### Building a Manure Composting System

The composting method described below is designed for a backyard or small farm operation with one to five horses. You can tailor this system to meet your needs depending on how many horses you have, the amount and type of bedding you use, and how you plan to use the finished compost. If you plan to use a tractor you will need a much sturdier design.

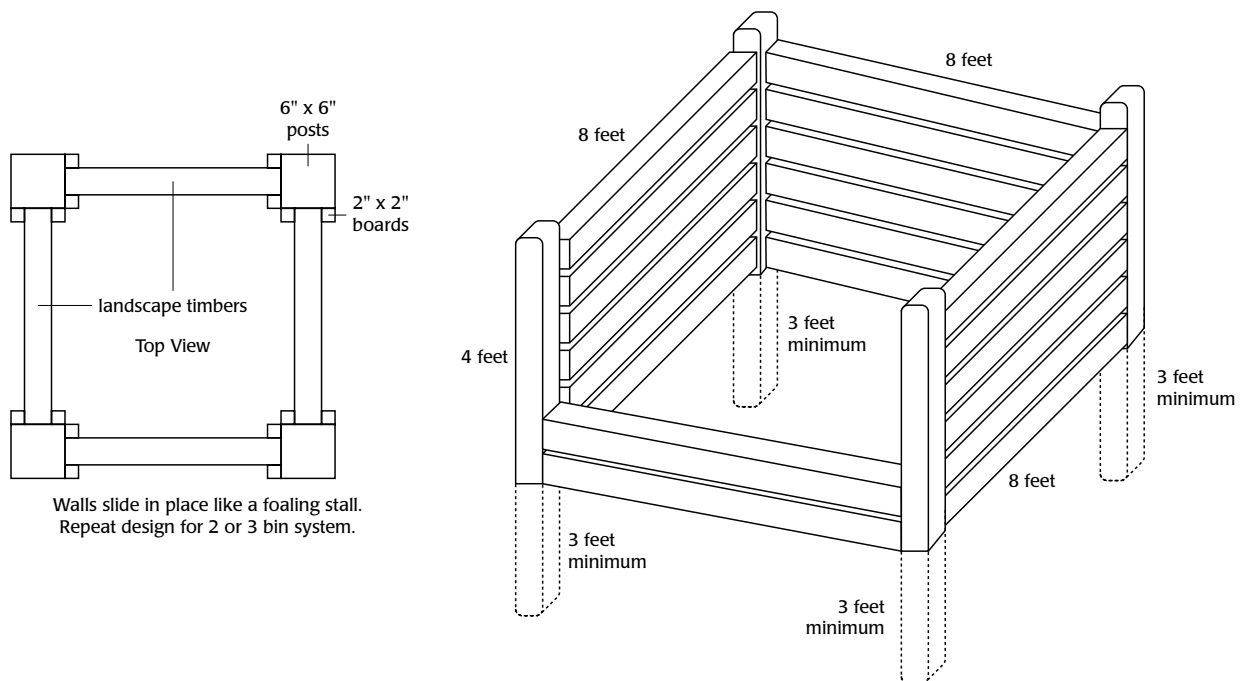



- **Planning out your system** After you've chosen a high, level area on your property (away from streams, ditches, wetlands, or other waterbodies), decide on the number of bins you'll need. Two bins will usually be adequate for one to five horses but you can add a third for convenience. Pile manure and stall wastes into the first bin until it is full, then leave it alone to compost and start filling the second bin. In two to four months the first bin should be done composting and ready to use or give away. For convenience, or if you have several horses, you may want to consider going to three bins. This allows one bin for the daily stall wastes, another bin which is full and in the composting stage, and a third bin for the finished compost to be removed and used at your leisure.
- **Covering your bins** It is important for the compost pile to be covered with a tarp, plastic sheet, or roof. This will prevent your piles from becoming too wet in winter and too dry in summer. This also prevents rainwater from washing nutrients out of the compost.
- **Getting air into the pile** An easy way to get air into the pile without turning it is to insert a couple of five-foot PVC pipes into the center of the pile like chimneys. Use a drill to put some holes in the pipes—approximately a half inch in diameter at six-inch intervals. The pile will still need to be turned occasionally to get the manure on the outside into the center where the heat from the composting process can kill parasites and weeds.
- **Finished compost** It will probably take about one to three months for each pile to compost, longer in the winter. You will know when your compost is ready when the material smells earthy and looks evenly textured and crumbly like dirt.
- **Building the bins** Below is a list of supplies and equipment needed to build three 4' x 8' x 8' bins. It costs about \$200 per bin for materials depending on the type of wood you use and the cost in your area.

**NOTE** *The number of landscape timbers will depend on the type and width of the timbers you purchase and how tall you wish to make your bins.*

Supplies	Equipment
8 – 8' 6" x 6" treated posts	drill with screwdriver head & bit
40 – 4' 2"x2" treated boards	25' tape measure
110 – 8' landscape timbers (or similar wood)	chain saw or hand saw
160 – 3" deck screws	carpenter's level
tarp (or plastic sheet) to cover top of each bin	post hole digger
	tamping rod or similar tool

### *Other Types of Composting Systems*

For larger facilities, such as those with more than five horses, there are a number of composting systems available that generally require more equipment and a greater initial investment. However, this investment can turn into a savings when compared with disposal costs.





The “Aerated Static Pile Method” is one composting solution for a medium to large horse operation. This method uses an aeration system—usually a system of perforated pipes connected to a blower—placed under the compost pile to periodically blow or draw air into the pile. A simple on/off timer is used to control the aeration rate. A typical setting might be 3 minutes on and 12 minutes off, running 24 hours a day, 7 days a week for 30 days or more. Adjusting the frequency and duration of airflow into the pile controls the temperature. This process generally provides more direct control of composting and permits larger piles.

Contact the Whatcom Conservation District or Natural Resources Conservation Service for more information on the system described above and other composting systems. There are also a growing number of businesses that can help you decide what composting system would be best for your facility, help you get a system in place, manage it for you, and find a market for your compost.

✓ *Apply Manure or Compost To Pastures*

- **Putting manure or compost to work** If you have pasture areas, the best way to get rid of your manure is to put it to good use. By spreading manure or compost on your pastures you’ll not only save money on disposal costs you’ll also improve the health of your soil and grass. Applied on pastures, one horse’s manure represents about \$150 in fertilizer value per year! Compost is a soil amendment that provides plants with nutrients, helps soil absorb water, and increases the organisms that keep soil healthy.
- **Manure spreading equipment** The easiest way to spread manure or compost is to use an actual manure spreader—a piece of equipment specifically designed for this purpose. Having a tractor (or a hefty riding lawnmower) to load and pull the spreader is particularly helpful. But you can also spread manure without all the fancy equipment: all you need is two people, a shovel, and a riding lawnmower,

**Troubleshooting the Compost Process**

Symptom	Problem	Solution
The compost has a bad odor.	Not enough air.	Turn the pile, add more PVC pipes.
The compost has a bad odor and is soggy.	Not enough air and too wet.	Mix in dry ingredients like straw or shavings, add PVC pipes, and cover with a tarp.
The inside of the pile is dry.	Not enough water.	Add water when turning the pile.
The compost is damp and warm in the middle but nowhere else.	Pile is too small.	Collect more raw material and mix it into the old ingredients. Piles smaller than three feet square have trouble holding heat.
The pile is damp and smells fine, but is not heating up.	Too many shavings, wood chips, or bedding and not enough manure.	Mix in a nitrogen source—straight manure, fresh grass clippings, bloodmeal, chicken manure, or nitrogen fertilizer (e.g., 21:0:0).





small cart, or pickup truck. Simply have one person drive while the other person spreads a thin layer of manure over the pasture area.

- **When and how much** Only spread manure or compost during the growing season (April-September) when plants can use it and when it's less likely to be washed away by rain. Early in the season—April, May, June—when grass is growing rapidly is the best time to do your spreading. As a rule of thumb, apply approximately  $\frac{1}{4}$  inch at a time—you don't want to smother the grass—and no more than three to four applications per year. Re-apply only after the previous layer has worked its way into the soil. For specific application rates based on the nutrient content of your stall waste, it's best to have it tested. Your local Conservation District, Natural Resources Conservation Service, or Cooperative Extension office (see the Resources section for contact information) can help you determine what soil testing you need to have done and help you interpret the results.

If you spread uncomposted manure, be sure you maintain a good deworming program. After spreading uncomposted manure on a pasture, let it age for a couple of weeks to a month before allowing horses to graze in that area. Aging the manure DOES NOT kill worm eggs; instead it allows the manure to decompose enough so that horses will be willing to graze—since horses naturally avoid grazing in areas with fresh manure.

### ✓ *Give Away Your Manure or Compost*

If you're not saving your manure or compost for your own use, giving it away can be a very effective disposal option. To make your give-away system as effective as possible:

- **Make your pile easy to access** If your pile is in a location where people can simply drive up to and take what they want, when they want, you'll get rid of a lot more stall waste than if you have to arrange a meeting time and let them in.
- **Make your stall waste attractive to gardeners** Many gardeners prefer either stall waste with little bedding or composted stall waste. The more desirable your product is the more attractive it will be for people to come and get it.
- **Advertise** Post a "free manure" sign where people can see it from the road and make it as obvious as possible where they need to go. Advertise by word of mouth: talk to all your non-horse neighbors and friends who would love some free fertilizer for their garden. Put an announcement in local newsletters and newspapers—many papers will let you advertise free stuff at no charge.
- **Take it to the source** If your manure is composted and you have the equipment to load and haul your compost, check with community gardens, local garden clubs, nurseries, landscapers, tree farms, and topsoil businesses for takers. You may even be able to make some money selling your compost if you're able to deliver it.

### ✓ *Consider Space Requirements*

Here are some factors that you may want to consider when figuring out how much space you will need for your manure or compost pile:



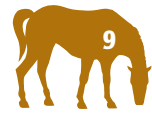

- How many horses do you have?
- What type of bedding and how much of it do you use?
- Will you be actively composting your manure? Composting can reduce a manure pile down to about 50 percent of its original size.
- How long will you be storing it—i.e., how much and how often do you expect to be spreading it on your pastures, giving it away, or having it hauled away?
- How healthy are your pastures? Healthy pastures with a good stand of grass will be able to use the nutrients in manure more effectively than overgrazed, weedy, or bare soils.
- What type of equipment will you be using? A large backhoe and dump truck will require more space than a small garden tractor with a manure spreader.

Here are some general space requirement guidelines that, after considering the factors above, should help you arrive at an estimate of how much space you will need:

- For six months of **uncomposted** manure and stall waste from one horse, you'll need approximately 10' x 10' x 10' of space.
- For a backyard composting system with one to five horses, without the use of a tractor or heavy equipment, use two to three 8' x 8' x 4' foot bins.
- If you are going to use a tractor to turn your compost piles, plan on two to three 8' x 8' x 4' piles for one to five horses. When using a tractor, it helps to place the piles on a cement pad. This makes it easier for the bucket to scrape the surface and keeps the tractor tires from tearing up the ground. A 30' x 30' foot area will house three piles with some room to move.
- For larger composting systems (five horses or more) where heavy equipment will be used, you may want to consider two three-sided cement bins approximately 16' x 16' or 35' x 35'.

### **High Bedding Users Take Note!**

If the stall waste you plan to spread on gardens or pastures contains a lot of shavings, you may not have a high enough percentage of nitrogen for it to be a good fertilizer. Applying stall waste with too much bedding may actually slow growth and cause yellowing of your grass plants. If this is the case, you may want to consider using your stall waste as a mulch around your property instead of as a fertilizer.

To solve the low nitrogen problem, you can add grass clippings, bloodmeal, chicken manure, urea, or nitrogen fertilizer to your manure as you pile it up. For best results, test the carbon to nitrogen ratio in your stall waste pile so you'll have a better idea of how much nitrogen you need to add. See the Resources section for a list of soil testing labs. Otherwise, a rule of thumb for adding nitrogen is 15 pounds of 21:0:0 per ton of manure and shavings—approximately a yard of soiled shavings with manure. (A cubic yard of stall waste is about equal to a pile two feet high in the center and four feet around, or about the size of a standard washing machine.)





✓ *Choose a Disposal Plan*

**Store manure and apply it to pastures.**

**Advantages** As discussed earlier, manure is a great fertilizer and if you've got enough pasture and don't want to go through the composting process, you'll be able to dispose of all your manure this way.

**Disadvantages** You'll need to have a good deworming program in place and if you have too much bedding in your manure, you may have to add a source of nitrogen to your pile. Also, if you don't have enough pasture, you may not have enough room to spread all of it. Composting can be a great solution to these problems.

**Costs** All you need with this option is something to cover your pile with and a way to spread the manure.

**Compost manure and apply it to pastures.**

**Advantages** Composting reduces the amount of manure you have by about 50 percent; kills worm eggs, pathogens, fly larvae and weed seeds; provides a great soil amendment.

**Disadvantages** Composting takes more time and money than stockpiling.

**Costs** If you use the composting system described in this chapter, you can expect to spend approximately \$200 per bin. You will also need equipment to spread the finished compost on your pastures.

**Testimonial**

Composting on a small place has proven to be a great asset. We set up a small two bin system which takes care of all of the manure from our one horse. We use all of the composted manure in our herb, vegetable and flower gardens as well as on our lawn. At times, we wish we had more compost for the whole pasture, too! Setting up the two bin system in a chore-efficient location was key to making composting easy and fun to do. We highly recommend it for even the smallest farm! Don't give away that black gold, keep it at home and use it to make your own place even greener!

**Liz & Ben Clark, Maple Valley, WA**

**Give away all the manure produced on your property.**

**Advantages** If you advertise well and your pile is in a good location, you'll probably be able to attract enough people to take all your manure away for you.

**Disadvantages** Manure can be harder to get rid of than compost and it can take some effort to attract enough people to your site to get rid of all of it. If your manure pile isn't easy for people to access, it can be a nuisance to meet and help people interested in taking it.

**Costs** Advertising, although there are also many ways you can advertise for free.





### Give away or sell your compost.

**Advantages** Compost can be a lot easier to give away, or even sell, than manure. If you've got good compost, you probably won't have to work too hard to get people to come and take all that you produce. If you're able to deliver it to landscapers, tree farms, or topsoil companies, you may be able to charge them for it and actually make a profit on your compost!

**NOTE** *If you are interested in selling your compost, check with the Whatcom Conservation District about local regulations.*

**Disadvantages** Composting requires an initial investment and ongoing labor. You'll probably have to put some time into researching companies that will pay you for your compost and then haul it to their site.

**Costs** The costs of getting a good composting system started varies but you may be able to make a profit on your investment. If you're hauling your compost off-site, you'll need equipment for loading and transport.

### Haul manure (or have someone pick it up) off your premises on a regular basis.

**Advantages** If you have a mountain of manure, lack of storage space, or not enough time to research or implement other options, paying to dispose of manure off-site may be the easiest way to go.

**Disadvantages** This can be more expensive than the other options. You may need to research disposal and/or hauling options.

**Costs** If you have the equipment to do your own hauling, you can haul your stall waste to a regional disposal or composting facility. Some facilities also rent out drop boxes that they will deliver and empty. They charge pick-up, rental, and disposal fees. Your local garbage hauler may be able to pick up and haul away stall waste as well.

*For facilities in your area, see the Resources section.*

#### **Testimonial**

In 1995, Woods Creek Horse Farm, a 12-horse training center in Monroe had an expense of \$4,800 per year for manure disposal, and they did the hauling. Woods Creek Farm then developed an "aerated static pile" composting system for their facility with help from Price-Moon Enterprises (see the Resources section for contact information). Today, they have converted a liability into a revenue stream by producing and selling over 1,500 cubic yards of compost annually. "We produce between three and four truckloads of horse manure compost each month, and we sell every bit of it to a large tree nursery nearby," says Darrel Parker. "By composting our horse manure and bedding, we have realized a net gain of roughly \$1,200 per month. The payback on Price-Moon Enterprise's training and equipment program was almost immediate."





## Manure Management Resources

### Facilities That Accept Manure And Stall Waste

We encourage you to also check with local farmers, landscapers, nurseries, topsoil suppliers, and construction companies that may be interested in horse manure and compost.

Resource/Location	Phone	Notes
<b>Arnold Finkbonner &amp; Sons Topsoil</b> Ferndale, WA	360-384-3232	
<b>Cedarville Farm</b> Bellingham, WA	360-592-5594	
<b>Washington Land Recycling</b> Burlington, WA	360-757-7211	Will accept horse manure at \$5/yard

### Alternative Bedding Sources

Check with your local feed supply store; most carry alternative bedding options. For sawdust and alder sawdust check with your shavings supplier. Woodstove pellet are usually available at feed stores, but also check hardware stores, grocery stores and woodstove shops. Be sure to use only pellets that contain 100% wood products with no chemicals, glue or other additives.

#### *Bear Mountain Forest Products Dry Den Stall Bedding*

Bear Mountain now has a line of farm bedding products. They manufacture all natural wood shavings (Cozy Den) and now offer a new wood pellet bedding called Dry Den which contains Zeolites for odor control.

Address: Bear Mountain Forest Products  
P.O. Box 70  
Cascade Locks, OR 97014

Phone: 541-374-8844                      Fax: 541-374-8837

Web site: <http://www.bmfp.com/>                      E-mail: [bearmt@gorge.net](mailto:bearmt@gorge.net)

#### *Woody Pet Professional Animal Bedding*

Woody Pet is presently shipping from four manufacturing facilities and is the largest supplier of 100% natural manufactured wood bedding in the world. Call or check out their web site for product information, delivered truck load pricing, and free samples.

Address: Woody Pet Products  
Woody Pet Acres  
16691 16th Ave.  
Surrey, B.C. Canada V3S 9X7

Phone: 604-535-9816                      Toll Free: 888-535-9816

Fax: 604-535-9861                      Toll Free Fax: 888-535-9861

Web site: <http://www.woodypet.com/>                      E-mail: [sales@woodypet.com](mailto:sales@woodypet.com)



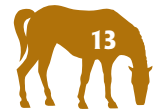

### *Peat Moss Bedding*

Check at local garden supply centers. Visit this web site for information on using peat moss as bedding: <http://horses.about.com/cs/horsecare/a/eqpeatmoss2467.htm>

Stallsorb's peat moss bedding is being used with good success at Emerald Downs Trace Track in Auburn, WA.

Phone: 360-825-3546

E-mail: [acestock@prodigy.net](mailto:acestock@prodigy.net)

### *Pelleted Bedding*

Reber Ranch

Address: 28436 132nd Ave. S.E.  
Kent, WA 98042

Phone: 253-630-3330

Fax: 253-630-3975

Web site: <http://www.reberranch.com/>

## **Manure System Building Materials**

There are several local building materials suppliers. Check your local phone book.

### *Eco-Block*

Concrete brick, barriers and forms.

Address: ECO-Block, LLC  
4100 North Powerline Rd.  
Building I, Suites 1 & 2  
Pompano Beach, FL 33073

Toll free: 800-595-0820 (US)

800-479-1066 (Canada)

Phone: 954-766-2900 (US)

905-377-0100 (Canada)

Fax: 954-761-3133 (US)

905-377-0200 (Canada)

Web site: <http://www.eco-block.com/>

## **Manure Management Consultants**

### *Price – Moon Enterprises, Inc.*

A comprehensive training program that provides the equipment, a detailed step-by-step training manual, and technical support to compost horse waste using the Aerated Static Pile Method. PME offers comprehensive training programs, packaged system designs, site-specific engineering services and assistance with product marketing. They also offer a full range of aeration and monitoring equipment design to maximize flexibility and minimize downtime. PME shows you how to convert a waste expense into a resource opportunity, with the combined benefit of cutting costs and adding new profit centers to your farm or business.

Address: Price-Moon Enterprises  
127 Ave. A, Suite 2D  
Snohomish, WA 98290

Phone: 360-563-6709, 800-611-3718

Fax: 360-563-5790

Web site: <http://www.o2compost.com>

E-mail: [O2compost@aol.com](mailto:O2compost@aol.com)





### N3, Nutrient Management Consultants

Phone: 360-352-3796

Toll Free: 888-404-3553

E-mail: [wym@earthlink.net](mailto:wym@earthlink.net)

### Books and Publications

**On-Farm Composting Handbook**, Robert Rynk, ed., June 1992, (NRAES-54), distributed by the Northeast Regional Agricultural Engineering Service.

Phone: 607-255-7654

E-mail: [NRAES@cornell.edu](mailto:NRAES@cornell.edu)

**On-Farm Composting Field Handbook**, a shorter publication about related farm topics, such as dairy expansion, lagoon management, and facility design and construction.

Phone: 607-255-7654

E-mail: [NRAES@cornell.edu](mailto:NRAES@cornell.edu)

**Biocycle Publications**, various publications on topics of commercial composting operations. Published by JG Press, 419 State St., Emmaus, PA 18049

Phone: 610-967-4135

Website: <http://www.jgpress.com/> and <http://www.biocycle.net/>

E-mail: [biocycle@jgpress.com](mailto:biocycle@jgpress.com)

**Worms Eat My Garbage**, How to set up and maintain a worm composting system, by Mary Appelhof; ISBN 0-942256-03-4, Flower Press, Kalamazoo, MI

### Websites Relating to Commercial Composting

Resource	Address
Cornell Waste Management Institute/Cooperative Extension	<a href="http://www.cfe.cornell.edu/wmi/compost/">http://www.cfe.cornell.edu/wmi/compost/</a>
University of Maine Cooperative Extension	<a href="http://www.umext.maine.edu/">http://www.umext.maine.edu/</a>
Department of Ecology	<a href="http://www.wa.gov/ecology/swfa/">http://www.wa.gov/ecology/swfa/</a>
Compost Resource Page	<a href="http://www.oldgrowth.org/compost/">http://www.oldgrowth.org/compost/</a>
U.S. Composting Council	<a href="http://www.compostingcouncil.org/">http://www.compostingcouncil.org/</a>
Composting Council of Canada	<a href="http://www.compost.org/">http://www.compost.org/</a>
Composting UK-An Information Source	<a href="http://www.dbcc.co.uk/">http://www.dbcc.co.uk/</a>
Compost Connection for Western Agriculture	<a href="http://www.csanr.wsu.edu/compost/newsletter/">http://www.csanr.wsu.edu/compost/newsletter/</a>
Worm Digest	<a href="http://www.worndigest.org/">http://www.worndigest.org/</a>
City Farmer	<a href="http://www.cityfarmer.org/">http://www.cityfarmer.org/</a>



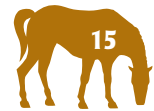

## Other Manure Management Resources

### *Whatcom Conservation District*

Phone: 360-354-2035

Web site: <http://www.whatcomcd.org/>

E-mail: [wcd@whatcomcd.org](mailto:wcd@whatcomcd.org)

### *Tilth Associations*

These organizations work to promote organic gardening, farming, composting and recycling. Some chapters advertise manure and compost (often for free) in their newsletters or on their web sites.

#### **Washington Tilth Association**

Address: 3830 S. 530 E.  
Greenbank, WA 98253

Web site: <http://www.tilthproducers.org/>

#### **Seattle Tilth**

Address: 4649 Sunnyside Ave. N.  
Seattle, WA 98103

Phone: 206-633-0451

Web site: <http://www.seattletilth.org/>

E-mail: [tilth@speakeasy.org](mailto:tilth@speakeasy.org)

### *Washington Organic Recycling Council*

An organization devoted to promoting the compost industry. Offers education and an in-depth, certified training program for compost operators.

Phone: 360-754-5162

Web site: <http://www.compostwashington.org/>

## Free Sources to Advertise Manure

### *The Little Nickel*

A classifieds publication that offers a free section where you can advertise your manure and compost at no charge. Also, check with your local paper to see if they also have a freebies section.

Phone: 425-743-1645

Web site: <http://www.littlenickel.com/>

### *Whatcom Conservation Newsletter*

Whatcom Conservation District publication that might put your ad in the announcements section.

Address: 6975 Hannegan Rd.  
Lynden, WA 98264

Phone: 360-354-2035

Fax: 360-354-4678

Web site: <http://www.whatcomcd.org/>

E-mail: [wcd@whatcomcd.org](mailto:wcd@whatcomcd.org)





# *Mud Management*



## **The Benefits of Reducing Mud**

If mud is an issue on your property (and it is for many), you may be under the impression that mud is an unavoidable part of having horses. But it doesn't have to be! There are some simple actions you can take to reduce or eliminate mud. And there are more than a few reasons to do so:

### **Mud creates an unhealthy environment for horses**

- Mud harbors bacteria, fungal organisms, and other pathogens that cause abscesses, scratches, rain scald, and thrush.
- The effects of repeated wet/dry conditions is damaging to hoof structure and can cause general unthriftiness.
- Mud is a breeding ground for insects such as culicoides ("no-see-ums"), filth flies, and mosquitoes. Insects are not only annoying, they can also carry diseases and cause allergic reactions (for horses and humans).
- When fed on muddy ground, horses can ingest dirt or sand particles with hay. This can lead to sand colic, a very serious digestive disorder.
- Mud creates slick, unsafe footing, increasing the risk of injury (again, for horses and humans).
- Mud in the winter is DUST in the summer's dry season – a potential health risk for your horse's fragile respiratory system, a potential problem for you (especially if you or a family member has allergy or respiratory issues) and it may be a concern for your neighbors as well.



### **Mud is inconvenient and unpleasant**

Mud makes everyday chores more difficult and is certainly a lot less appealing to the eye (for you and your neighbors) than a nice dry paddock and grassy pastures.

### **Muddy waters**

Once soil and manure has mixed with water to make mud, it can easily be carried into nearby streams or lakes. Sediment can smother trout and salmon eggs, destroy habitat for insects (a food source for fish), and cover prime spawning areas. Many pollutants, like the nutrients in manure, are also likely to attach to soil particles and be carried into the water.

### **A Recipe For Mud**

A few key ingredients to a muddy horse property:

- **Manure, manure everywhere** Manure is great at holding moisture; that's one of the reasons it's so valuable in a garden but also why it contributes to mud in horse confinement areas.
- **Traffic jam** In high-traffic areas (such as paddocks or stall entryways), horse hooves loosen topsoil and compact the soil below. As the soil becomes more and more compacted with the constant pounding of heavy horse hooves, rainwater isn't able to percolate through the soil and instead pools on top, mixing with the loose topsoil to create mud.
- **Just add water** Of course you've got to have water to make mud, and in the Northwest we've got plenty of that. The rainwater that runs off of impervious surfaces like your barn's rooftop can compound the problem. If that rain isn't directed away from high-traffic areas, you've got plenty of water to make mud.

## **What You Can Do**

### **✓ Pick Up Manure Often**

- **Manure = Mud** Manure is great at holding moisture. By picking up manure in stalls, confinement areas, and paddocks every one to three days, you'll greatly reduce the buildup of mud. In fact, this is probably the single most important aspect of eliminating mud. Picking up manure often also has the added benefit of reducing parasite reinfestation.

### **✓ Practice Good Pasture Management**

- **Create a sacrifice area** A winter confinement area, also called a sacrifice area, is a small enclosure such as a paddock, corral, or pen. It is called a sacrifice area because you are giving up the use of that small portion of land as a grassy area to benefit the rest of your pastures. Horses should be confined to the sacrifice area through most or all of the winter and early spring.
- **Use a rotational grazing system** By dividing a pasture area into smaller fields and rotating horses through them during the spring and summer, you can encourage horses to graze more evenly, keep pasture grasses from becoming overgrazed, and guarantee fresh grass for a longer period during the growing season.

*For more information on sacrifice areas, rotational grazing, and keeping pastures healthy, see the Pasture Management section.*



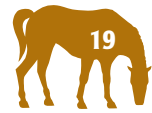

### ✓ Apply Footing Materials

- **Purpose** Footing, such as hogfuel (chipped or shredded wood products), gravel, or sand can go a long way in reducing mud. Footing material is useful for confinement areas or other high-traffic areas (such as the area around gates or watering points). The purpose of footing material is to build up an area to keep horses up out of the dirt and allow rainwater to drain through.
- **Types** Although there are many products that can be used for footing materials, you'll find gravel and hogfuel most commonly used in the Northwest. Some types of sand can also work well but avoid feeding horses on it. Ingesting sand or dirt particles with hay can result in serious sand colic problems. You can also try a combination of footing types, for example, gravel in higher traffic areas and hogfuel in the rest, or a sand or gravel base with hogfuel on top.
- **Hogfuel** Hogfuel provides a good surface and, through natural decomposition, breaks down the nitrogen in urine and manure. This helps eliminate urine smell and reduces the amount of nitrogen that could run off into streams. However, hogfuel does have some disadvantages. Hogfuel holds moisture and tends to be wetter than some other types of footings. And since it is organic, it will continue to decompose over time. This means that you'll need to get more to replace the hogfuel that has broken down—although you'll probably never have to get as much as the first year's amount. It also means that as it breaks down it can turn to mud once water is added. To prevent this, each year plan to remove the hogfuel that has decomposed into fine material before you bring in a new load. You can do this with a shovel or the aid of a tractor and bucket, depending on the amount you have. Remove the old material during the dry months and add it to your

#### Be picky when purchasing hogfuel

Hogfuel is made from chipped stumps or branches and can provide a good footing surface for horse confinement areas. The name "hogfuel" originates from the early days of logging when trees were run through a steam-powered machine called a "hog" or "hogger" that chipped the bark off of the trees. This chipped material was then used as fuel to run the hog, thus the name "hogfuel."

Hogfuel products vary widely so be sure you are getting what you want before you order any. Visit the supplier and inspect the type of hogfuel you would be purchasing or, even better, visit horse facilities where the hogfuel is being used and ask the owner how effective it has been.

Find out from your supplier if the type of wood in the hogfuel is appropriate for horses—many landscaping trees can be toxic to horses! Hogfuel around the Northwest is usually made from a combination of cedar, fir and hemlock—any of which are fine. Cedar will last longer because of its natural ability to repel insects. It also has a very pleasant smell. However, it may hold a bit more moisture than other types of wood products and a very small percentage of horses may be allergic (skin sensitivity) to cedar. To test this beforehand, try a bag of cedar shavings as bedding for a week or so to see how your horse does.

Also, look at the size of the wood chips in the hogfuel to be sure that they are neither too large nor too small. If the chips are too big it can be hazardous for horses and make it difficult to pick up manure. On the other hand, hogfuel chips that are too small will decompose quickly.

Finally, be sure that there are no nails, metal, or other foreign objects in the material; and be home on delivery day to be sure that you get what you ordered!





compost pile. Because of hogfuel's tendency to decompose fairly quickly, avoid using it in very wet areas or very organic soils where it will just turn into muck. Consider using tree trimmings, often available for free from local power companies or tree service businesses, in high-traffic non-horse areas (such as walkways or outside gates) where horses won't be tempted to browse it for food.

- **Gravel** Gravel (crushed rock, no larger than  $\frac{5}{8}$ "—anything larger will be uncomfortable for horses) is another good footing to consider. It is especially useful in the highest traffic areas, e.g., in front of stalls, gates, and watering points. It won't break down like hogfuel does and it drains well. Gravel is roughly two to three times as expensive as hogfuel but you probably won't have to replace it every year.
- **Other materials** There are a lot of other potential footing materials available. Sometimes second-hand products such as dryer felt or used belting from gravel or paper companies are available for free or at a low cost. These products can work as mats for wash racks, aisleways, or feeding areas. Old, jute-based carpet turned upside down can also work for smaller areas. Rubber stall mats are more pricey but very useful and durable.

### How deep?

Use **at least** three inches of footing, preferably six: more is better when it comes to footing. If you already have a lot of mud you may want to either remove some of the existing mud or else plan to put in footing on at least a 1:1 ratio (for example, if you have about six inches of mud you'll need at least six inches of footing). If your soil is especially mucky, you may want to consider first laying down some type of filter fabric and using another footing on top. Filter fabric can be purchased through garden supply and hardware stores.

### When to buy it?

No matter what type of footing you decide to get, remember one thing: get it in the summer! Wood products like hogfuel are more readily available in the summer since there is less of a demand for it as power plant fuel. During the summer when burning bans are on, contractors are often looking for cost-effective ways to get rid of stump grindings. But the key reason for getting your footing material in the summer is that it is easier to deliver in the dry months. Imagine trying to guide a big truck through a ruddy pasture and down a slippery hill in the middle of a downpour—not to mention competing with all the other customers who waited until the last minute! Footing applied when the ground is dry will also be much more effective at preventing mud than footing added after the mud is already there.

### ✓ *Install Gutters and Downspouts*

- **Now that's a lot of water** On just a 900-square-foot barn (approximately 30' x 30') a one-inch rainstorm produces 558 gallons of water! If all of that water runs off of your roof and straight into your confinement areas, you're going to end up with a lot of mud.





- **Keep clean rainwater clean** The rainwater that enters your confinement areas not only creates mud, it can also cause water pollution. When clean rainwater runs through a horse pen, it mixes with manure and soil, instantly going from clean to contaminated. As that water travels to the nearest waterbody, it will carry with it those contaminants. However, by using gutters and downspouts to divert the rainwater away from confinement areas, you'll keep clean water clean.
- **Divert rainwater** By installing gutters and downspouts on your barn and other buildings, you can divert rainwater away from your sacrifice areas and other high-traffic spots. Decreasing the amount of water that reaches these areas will greatly reduce mud. Divert clean rainwater to stock watering tanks, rain barrels, an undisturbed area of your pasture, or other vegetated areas. Be sure to protect downspouts so horses don't destroy them. This can be done with heavy PVC pipe, hot wire, or by simply making the downspout area inaccessible to horses.
- **Other ways to divert water** After you have your gutters and downspouts installed, watch where the water travels during the next big rain. If rainwater is flowing into your confinement areas, you may want to look at other ways for redirecting this water. Installing a french drain—a trench loosely filled with coarse gravel—is one way to redirect water. The gaps between the stones serve as a passageway for water and lead to an outlet, such as a grassy area. Other structures such as water bars (like a speed bump for water), swales (grass-lined channels), or dry wells (pits lined with gravel) can also help keep rainwater out of your confinement areas. Contact the Whatcom Conservation District or Natural Resources Conservation Service for more information on each of these techniques.

*For more information, see the Resources section.*

### ✓ **Keep Horses Out of Streams and Wetlands**

Fencing horses out of streams (or any other waterbodies on your property) and wetlands will also prevent mud. Horses often congregate around watering areas and are likely to overgraze the area and trample streamside vegetation. The loss of vegetation and addition of manure will lead to an unattractive mud hole in winter and harm fish and shellfish downstream. Easy, cost-effective watering systems are available that can provide water sources away from streams. You can also build water crossings and watering points to limit the amount of access horses have to the waterbody (contact the Whatcom Conservation District or Natural Resources Conservation Service for technical assistance).

Wetlands will also turn to mud with the impact of horses. The pounding of heavy horse hooves on wet soils compacts the ground, suffocating plant roots and preventing water from soaking into the ground. This, and contamination by manure, can cause serious damage to wetlands. Wetlands are nature's filter systems for our water and can also help to reduce flooding.

*For more information, see the Stream and Wetland Management section.*





✓ *Cover Your Manure Pile*

Covering your manure pile (with a tarp or roof) will prevent rain from turning it into a pile of mush. The nutrients you are trying to save will stay in a covered pile and not get washed away into nearby streams and lakes or seep through the soil into groundwater. Be sure to store manure as far away as possible from streams, ditches, or wetlands to avoid more mud problems and contamination of waterbodies.

✓ *Plant Trees*

Trees drink a huge amount of water and they can significantly reduce the amount of water around your horse facility. A mature Douglas fir can drink 100-250 gallons per day. Evergreens have the added advantage that they keep on using water in the winter when deciduous trees are dormant. Planting water-loving natives like willow, cottonwood, red osier dogwood, and hybrid poplars along the outside of sacrifice areas can help keep the area drier. Trees planted inside pastures and paddocks will need protection from chewing and root compaction. Fence off these trees along their drip zones (the ends of the branches where the raindrops roll off). Consider planting new trees where horses can't reach them. By planting trees you will also provide shade for horses and habitat for wildlife. Be aware that some fruit trees and ornamental landscaping trees may be toxic to horses.

*For more information on toxic plants, see the Pasture Management section.*

## Mud Management Resources

### Used Conveyor Belting Sources

Sand and gravel companies are a typical resource for used conveyor belting. See the Whatcom County local phone book for a list of companies near you.

### Hogfuel & tree Trimming Sources

See the Whatcom County local phone book for other tree trimming services.

Resource	Phone
Whatcom County Public Works	360-676-6692
Puget Sound Energy	800-321-4123
Asplundh Tree Service	425-483-9339
Whatcom County Public Works	360-676-6692

## Other Mud Management Resources

### *Whatcom Conservation District*

Phone: 360-354-2035

Web site: <http://www.whatcomcd.org/>

E-mail: [wcd@whatcomcd.org](mailto:wcd@whatcomcd.org)



# *Pasture Management*



## **The Benefits of Good Pasture Management**

A pasture full of healthy grass does more than create a pretty picture that you and your neighbors will appreciate; there are some other important benefits:

- **Seeing green—lower feed costs** A healthy pasture can also provide horses with high quality, nutritious feed at a low cost. Pastured horses are also less likely to develop destructive habits like wood chewing and stall kicking.
- **Protecting horse health** A pasture full of grass instead of mud reduces a horse's chance of getting colic from eating dirt or developing respiratory problems from breathing dust. It also reduces breeding grounds for insects and disease. Weeds that can poison horses are less likely to crowd their way in where grass is plentiful and, with healthy forage, horses won't be as tempted to eat weeds. Having time to graze in a pasture is also good for the psychological well-being of horses—it gives them fresh air, sunshine, and socialization.
- **Protecting water quality** When pastures are thick and grassy, they do a great job of anchoring valuable topsoil in place, filtering pollutants, and making use of the nutrients from manure. As a result, you get to keep soil and nutrients **on** your property and **out** of our streams and lakes.



## What You Can Do

### ✓ *Create Sacrifice Areas*

- **Time out** Probably the most important aspect of managing pastures is the time you take horses off the pasture. Keeping horses off (or at least limiting their amount of time on) rain-soaked or frozen pasture is critical if you want to maintain healthy grass plants. Saturated soils and dormant plants cannot survive continuous grazing and trampling, especially during winter months. The pounding of horse hooves compacts wet soils, suffocating plant roots. Horse hooves also act like plungers by loosening topsoil, allowing it to be washed away by the rain.
- **What is a sacrifice area?** A sacrifice area is a small enclosure such as a paddock, corral, pen, or turnout area. It is called a sacrifice area because you are giving up the use of that small portion of land as a grassy area to benefit the rest of your pastures. Horses should be confined to the sacrifice areas throughout most or all of the winter and early spring.
- **Location, location, location** To create a sacrifice area, choose an area on higher, drier ground, away from wetlands, streams, or ditches. For chore efficiency, keep the area close to the barn. You may want to have one sacrifice area per horse set up like a run off of each stall. This will allow horses free access to the stall and will give you a clean, dry, convenient place to feed.
- **Size** The size of a sacrifice area can range from a double box stall (about 12' x 24') attached to a stall, to a long, narrow enclosure that allows horses to run and play. You may just have several turnout paddocks that you rotate stalled horses through during the day to give them a chance to move about. Approximately 20 or 30 feet wide by 100 feet in length will allow a horse to trot, 200 feet in length to gallop. The amount of land you have available and the number of horses and their temperaments will all affect the size of the sacrifice areas you need. Keep in mind that the larger the sacrifice area, the larger the area you'll have to clean and the more footing you'll need to purchase.
- **Buffers** Surround sacrifice areas with at least 25 to 50 feet of lawn, pasture, trees, or bushes. This vegetative buffer will act as a mud manager for surrounding areas and naturally filter contaminated water running off sacrifice areas.

*For information on footing and other tips on how to eliminate mud in sacrifice areas, see the Mud Management section .*

### ✓ *Use a Rotational Grazing System*

- **A fancy name for a simple concept** Think of yourself as a grass farmer! By dividing a pasture area into smaller areas and rotating horses through them, you can use your horses as lawnmowers and encourage them to graze more evenly. Once horses have grazed a pasture area down to three or four inches, you rotate them

### **Limit Spring Grazing**

Remember to limit turn-out time when horses begin grazing again—too much grass can cause very serious horse health problems, especially in the spring when grasses are rich and lush. Increase grazing gradually. Start with about an hour at a time, and work up to several hours over a period of several weeks. If you have any questions about how much grazing time is safe for your horse, consult your veterinarian for his/her recommendations.





on to the next pasture. This keeps pasture grasses from becoming overgrazed, discourages selective grazing, and guarantees fresh grass for a longer period during the growing season.

- **Give grass a chance** Grass plants cannot survive if they are continuously overgrazed. Like all plants, grass plants need their leaves to gather energy from the sun. The plant needs this energy to manufacture food, grow, and reproduce. The ability of grasses to recover quickly makes them valuable for grazing. Removing too much of the leaf, however, will slow regrowth and damage the root system. The plant will eventually die, allowing weeds to take over, if overgrazing continues.
- **The golden rule of grazing** The golden rule of pasture management is to never allow grass to be grazed shorter than three inches—this ensures that the grass will have enough reserves left after grazing to permit rapid regrowth. Consider the bottom two or three inches of grass an energy collector that needs to be left for the plant. Once horses have grazed the majority of the grass in a pasture down to three or four inches, rotate them on to the next pasture. You can put horses back on pastures when the grass has re-grown to about six to eight inches. This usually takes two to six weeks during the growing season (April to September).
- **Limited space** Not everyone has endless fields of grass and horses may graze down all your available pasture to three inches. At this point you can use sacrifice areas until the grass has had time to grow back to six or eight inches. You can also lengthen the lifespan of your pasture by letting horses graze for shorter periods of

### The Nuts and Bolts on Sacrifice Areas

- **Fencing** Choose the very safest fencing you can for your sacrifice area. Whatever type of fencing you choose, you may want to reinforce it with some type of electric tape or hot wire that provides a good “psychological barrier.” Horses are hard on fences and will test most types but they tend to have more respect for electric fencing.
- **Accident Prevention** Be sure that there are no protruding objects like bolt ends, nails, boards, or the tops of metal T-posts in your sacrifice area. Also watch out for the corners of roofs and the bottom edges of metal building materials. Look for any hanging wires or cords and remove any garbage or machinery in the paddock.
- **Accessibility** Keep in mind that gates need to be wide enough for delivery trucks—about 12-foot wide should do it. It’s also important to have a road or driveway leading into your sacrifice area that will be accessible year-round. Remember that the vet, farrier, and delivery vehicles will need easy access even in the winter months. Be sure that your road or driveway won’t be too muddy or narrow, that you’ll be able to clear it of snow if necessary, and that there aren’t any low-hanging wires or tree branches.
- **Chore Efficiency** Here are some questions to ask yourself when choosing the location of your sacrifice area: Will sacrifice areas be near your manure pile and hay storage for ease of daily chores? Can deliveries be made without moving horses—will people have to drive through a pasture to get to your sacrifice area? Do your horses have easy access to fresh water? Can horses be fed without walking through sacrifice areas? This is especially important if you ever plan to have inexperienced people feeding—you may not want them in with your horses. Can you move horses to pasture areas or elsewhere with ease? Are alleys and paths wide enough for wheelbarrows or any other equipment you expect to use?





time. This is always a good idea when you first start allowing horses to graze pasture—too much grass can cause serious health problems, especially in the spring when pastures are particularly rich. Begin pasture grazing time gradually, starting with about an hour at a time and work up to several hours (or less, if your grass is limited) over a period of weeks.

- **Winter break** For healthy grass plants, it's best to keep horses off pastures until spring when grass is no longer dormant. Since grass plants are not actively growing in the winter, they can easily become overgrazed. Soggy winter soils are also easily compacted by the weight of horses, suffocating the roots of grass plants. A simple test for soggy soil is to walk out in your fields and see if you leave a footprint; if you do, you know that it's too wet and that your horse will be sure to compact the soil. If you do turn horses out on pastures during winter months, at least limit the amount of time to reduce compaction and overgrazing.
- **Types of fencing for rotational grazing** When using a rotational grazing system, you can separate grazing paddocks with permanent or temporary (usually electric) fencing. It's generally easiest to establish as many permanent grazing paddocks as you think you'll need—you can always hook up temporary electric wire or tape if you need to subdivide further. However, if you want to keep fencing costs down you can also move temporary fencing with the horses as you switch them from one grazing area to another. As a first step towards a rotational grazing system, you may want to first try dividing an existing large pasture in half and alternate grazing. Then try further subdividing after gaining some experience. Portable electric fencing is lightweight, inexpensive, and easy to move for pasture rotation. High tensile electric fence or New Zealand style fencing is also inexpensive and requires little maintenance.
- **Plan Your Pastures** Try fencing pastures according to how wet they are. In the spring, let horses onto the higher, dry areas first. Save the wetter areas until later in the summer when they dry out. Make sure pasture areas are large enough for horses to run and that gates are placed so that horses can be easily led from stall to pasture and back.
- **Water** Remember to have a source of water for each pasture. You can have separate water sources for each pasture or a single water source that is accessible from more than one pasture. Also try to divide pastures in such a way that horses can have access to shade or shelter especially if they will be confined to these areas for more than a few hours.

### Protecting Your Septic System

For those of you with septic systems, it is important to keep vehicles, heavy equipment, and horses off your drainfield and replacement area (the area required should your existing system need an addition or repair). The pressure from vehicles and livestock can compact the soil and damage pipes. Do not place impermeable materials such as concrete or plastic over these areas either. These materials reduce evaporation and the supply of oxygen to the soil needed for proper effluent treatment. Grass is the best cover for your entire system. For more information on caring for your septic system, contact your local health department.





### ✓ *Actively Maintain Your Pastures*

- **Mowing** Mowing your pastures cuts all of the plants to the same height, stimulating equal growth, cutting weeds before they have a chance to go to seed, and preventing grass plants from getting too tall and tough to be appetizing to horses. Mow pastures to a uniform four or five inches after horses have completed grazing the area.

#### **The Low-Down on Pasture Equipment for the Small Horse Farm**

The equipment you use to keep your pastures healthy doesn't have to be complicated or expensive—it all depends on the size of your place and your needs.

- **Lawnmowers** Since you only need to mow your pastures three or four times per year (after horses have completed grazing the area), a traditional upright lawnmower or riding lawnmower is very effective for the small farm. If you have three acres or less, you'll probably be able to use a traditional lawnmower. For those with about three to five acres, a riding lawnmower may be your best bet. Riding lawnmowers can actually be an advantage over larger equipment like a tractor—they are much more maneuverable and can make tight corners and frequent turns with ease. They're also great for other uses around the small farm. Riding lawnmowers (16 to 18 horsepower) can pull other farming implements like small harrows, manure spreaders, and seed spreaders. Whether you use a traditional upright lawnmower or a riding lawnmower, set your mower as high as it will go—at least four inches, five or six is even better. Also use a mulching mower if possible. The grass clippings left on your pastures will act as a natural fertilizer and it will save you the trouble of hauling and disposing of the clippings.
- **Harrows** Harrows are used for spreading out manure piles in pastures and can also be used to smooth arena surfaces. For small areas, harrowing can be accomplished manually with a manure fork. You can make a basic harrow by attaching a piece of chain-link fencing (about 6' x 6') to two boards, one on each end. Add two tires tied down for weight. An old metal bedspring or gate can work as a harrow also. If you want to buy the real thing, a wide variety of harrows can be purchased from farm and tractor supply stores and catalogues or at farm auctions; you can also look for ads in the back of horse or farm magazines, or in *Capital Press*.
- **Manure spreaders** A small, ground-driven manure spreader can make the job of spreading your manure or compost throughout your pastures a lot easier. There are many varieties of manure spreaders and finding the right one for you and your situation will probably take some looking around. When shopping around, be sure the spreader is a size your riding lawnmower or truck can handle and that it's not too big or long to maneuver around your pasture areas, especially the corners. And most importantly, make sure the spreader is adapted for horse manure or composted horse manure and not cow manure. Cow manure is softer and breaks apart more easily (more "pie" shaped) which makes a difference in how the tines in the spreader are structured.
- **Utility trailer** A small utility trailer is great for hauling hay bales, water, fencing, tools, trees to be planted, even garbage cans (a long haul to the end of the driveway for many in rural areas). There are a lot of different types and sizes of trailers on the market—again, just be sure to get one that can be pulled by whatever vehicle you plan to use and easily maneuvered in the space you have.





- **Dragging** Dragging can be done with a harrow (a tool specifically for this purpose) or homemade devices such as a chain link fence or an old bedspring. Drag your harrow around the pasture with a riding lawnmower, tractor, or pickup truck to break up manure clods and spread them evenly throughout the area. This will help make the nutrients in the manure available throughout the pasture and keep the manure from smothering grass plants. Once you've gotten a good rotational grazing system down and have been mowing and dragging regularly, you might find that horses no longer create a "rough" (the area horses use to urinate and defecate) and that they distribute their manure more evenly.
- **Applying manure** Spreading manure—composted or fresh—on pastures can improve the health of your grass and help you dispose of horse wastes. Once horses have grazed the pasture down to three inches and you've mowed and dragged, apply your compost or manure. You can use a conventional manure spreader (wagons with a mechanical apparatus designed to distribute manure) or simply spread it with a shovel from the back of a moving pickup truck or riding lawnmower. Apply approximately  $1/2$  inch at a time and no more than two to three inches per year. By the time the grass has had a chance to grow back to six or eight inches, the pasture will be ready for grazing again. If you plan to use fresh manure (instead of compost) be sure to maintain a good deworming program. Only spread manure and compost during the growing season (April-September) when grass can use the nutrients and rain is less likely to carry them away. The best time of year to spread manure is early in the growing season—April, May, June. Fifty percent of grass growth occurs by the end of June.
- **Soil testing** A soil test can be a useful tool in pinpointing the amount of nutrients in your soil. This will help you avoid over-application of fertilizer, which will save you money and keep excessive fertilizers from running off your property and polluting streams and wetlands. Fall is the best time for soil testing. See the Resources section or contact the Whatcom Conservation District for information on labs that do soil testing.
- **Fertilizing** Once you've found out from your soil test what nutrients your pastures need, only apply fertilizers during the growing season when plants can utilize the nutrients. Fertilizers applied during the rainy season when plants are dormant are likely to be washed away (along with the money you've spent) and end up harming surrounding surface waters more than helping your pastures. Applying the right amount of fertilizer at the right time can increase plant yield, improve water use-efficiency, and decrease weed problems by making your grass plants so vigorous that weeds cannot get established.
- **Aerating** If soils are compacted you may want to aerate in the spring or early summer when grasses are actively growing and fill in rapidly. Aerators can be rented from farm equipment suppliers; you may even be able to borrow one from a local golf course.
- **Green band-aid** Scatter pasture grass seed over bare spots and pat firmly into the soil. A bare spot in the summer is mud in the winter and weeds next spring.





- **Renovating** In western Washington even worn down pastures rebound under good pasture management. Renovating or reseeding a pasture is not always necessary to bring a pasture back to productivity. Therefore, establishing a rotational grazing system, mowing and dragging, overseeding, soil testing, and fertilizing should always be tried before renovating a pasture. See how the grasses respond and use reseeding and renovating as a last resort. If you don't have a good rotational grazing system, reseeding is likely to be a waste of time and money. If you do reseed, consider soil types and how you will be using the pastures in order to select the appropriate seed. If you think renovating is necessary, you may not need to plow up your entire pasture if it's not completely compacted. If you pick grass plant species that are better for your soils than the ones that are already there, the new grass is likely to take over. Contact the Whatcom Conservation District, Natural Resources Conservation Service, or Cooperative Extension.

*For more information, see the Resources section on soil testing, pasture plant varieties, fertilizers, and a timetable for planting.*

### ✓ Control Weeds

- **Keep an eye out** It's important to regularly survey your property for weeds, particularly those that are poisonous to horses. Weeds can spread rapidly and push out the grass plants you want. Be especially watchful at the beginning of the growing season when weeds sprout faster than grass and at the end of the growing season when grazed areas are more barren, leaving horses fewer forage options. Because it is hard to always catch weeds before they spread, prevention is the best weed management policy.
- **Weed prevention** Good pasture management is the best weed control—healthy grass will prevent weeds from pushing their way in and will also keep horses from being tempted to nibble on weeds when they do pop up. Here are a few other things you can do:
  - Make sure that the hay you buy is weed-seed-free.
  - Use certified grass seed on your property.
  - Mow pastures regularly before weeds have a chance to go to seed and to prevent them from shading out developing grass.
- **Herbicides** Whenever possible, and especially near streams and wetlands, remove weeds by hand rather than with chemicals. Chemical herbicides may be harmful to horses and can be very toxic to fish and other aquatic life. It's easy for chemicals sprayed on weeds to wash off in the rain and travel to nearby streams. If you decide to use herbicides, be sure the product you're using is effective for the weed you are trying to control. Only spray areas with weeds and be aware of wind drift. Don't think that if a little is good, a lot is better—you could do serious damage to your land and the environment. Always read and follow directions carefully.
- **Toxic Weeds** Some of the plants found in Western Washington that can be toxic to horses are listed in the table below. Be aware that many landscaping plants and fruit trees can also be toxic to horses.

*For more information, see the "Pasture Management Resources" in the Resources section on obtaining a more complete list of toxic plants.*



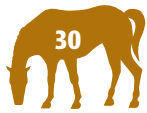

Species	Location/Season	Toxin & Toxic Dose	Symptoms	Comments
<b>Buttercup, creeping</b> <i>(Ranunculus repens)</i>	Moist soils pasture overgrazed	Protoanemonin Very large	Inflammation	Rarely eaten unless and narcosis
<b>Camas, death</b> <i>(Zigadenus venenosus)</i>	Spring	Steroidal, glycosidal, alkaloid Less than 9 pounds	Salivation, weakness, respiratory difficulty, nausea, convulsions, coma	Deadly, easily confused with edible camas after bloom
<b>Fern, bracken</b> <i>(Pteridium aquilinum)</i>	Fall, when pastures overgrazed	Thiaminase Cumulative large quantities	Appetite loss, timid, stupified, incoordination	
<b>Fiddleneck</b> <i>(Amsinckia sp.)</i>	Overgrazed pastures	Pyrrolizidine Single dose 20 pounds or cumulative	Liver damage & failure, depression, dermatitis, incoordination, death	Similar poison to Tansy Ragwort
<b>Foxglove</b> <i>(Digitalis purpurea)</i>	Acid soils	Digitoxin & other glycosides Very toxic (1/4 pound)	Contracted pupils, labored breathing, convulsions, death	Rarely eaten fresh, dangerous in hay
<b>Hemlock, poison</b> <i>(Conium maculatum)</i>	Ditches, moist disturbed areas	Coniine and other alkaloids Very toxic (5 to 10 pounds)	Narcosis, paralysis, death	Hay MAY be somewhat less toxic as the poison will slowly evaporate
<b>Hemlock, water</b> <i>(Cicuta douglasii)</i>	Low, wet areas; in spring roots pull out of known ground easily	Cicutoxin Very toxic (.2 to .8 pounds)	Teeth grinding, muscle spasms, respiratory failure, death	Roots & stem base most toxic. The most poisonous plant in North America
<b>Horsetail</b> <i>(Equisetum arvense)</i>	Moist areas	Thiaminase Large quantities cumulative	Thiamine deficiency causes appetite loss, incoordination	Poisoning occurs when dry plants are fed in hay





Species	Location/Season	Toxin & Toxic Dose	Symptoms	Comments
<b>Knapweed, Russian &amp; Yellowstar thistle</b> ( <i>Centaurea spp.</i> )	Disturbed areas	Cumulative (600 pounds?)	Brain deterioration resulting in "Chewing disease"	Can eventually cause death by starvation
<b>Larkspur</b> ( <i>Delphinium spp.</i> )		Alkaloids-delphinine Very toxic (1 pound)	Constipation, bloat, depression, paralysis	Deadly
<b>Lupine</b> ( <i>Lupinus spp.</i> )		Alkaloids-lupinine 600 to 800 pounds	Spasms, cerebral excitement & death	Can cause birth defects if eaten during pregnancy
<b>Nightshade, black</b> ( <i>Solanum spp.</i> )	Late summer, early fall, fencerows	Alkaloid-solanine 1 to 10 pounds	Diarrhea, convulsions, incoordination, death	
<b>Oak</b> ( <i>Quercus spp.</i> )		Tannins? Very large	Constipation, blood in urine	Leaves can cause problems, acorn poisoning more ommon
<b>Ragwort, tansy &amp; Common groundsel</b> ( <i>Seneclo spp.</i> )		Alkaloid- pyrrolizidine	Liver Lesions, weakness, staggering, death	Liver damage is permanent. Normally avoided when fresh, eaten in hay or when wilted.
<b>Rhododendron</b> ( <i>Rhododendron spp.</i> )		Glycosides Small	Vomiting, vertigo, death from respiratory failure	
<b>Yew</b> ( <i>Taxus spp.</i> )		Alkaloid-taxine 1 to 10 pounds	Gastroenteritis, labored breathing, trembling, collapse	Rarely eaten fresh, dangerous in hay

Excerpted from: Pasture Management for Horses and Ponies, Gillian McCarthy; and *Plants that Poison Livestock in Thurston County*, Thurston County Noxious Weed Control Agency.





## Pasture Management Resources

Test your own soil quality with a Soil Test Kit. Visit the Soil Quality Institute web site:  
<http://www.statlab.lastate.edu/survey/SQI/sqihome.shtml>

### Soil Testing Labs

Resource/Address	Phone	Fax	Web Site/E-mail
<b>AAA Superior</b> 404 First Street Cheney, WA 99004	509-235-9390 509-448-1740		
<b>A &amp; L Western Agricultural Laboratories</b> CA Office: 1311 Woodland Ave., Suite 1 Modesto, CA 95351-4732	209-529-4080	209-529-4736	
OR Office: 10220 SW Nimbus Ave., Bldg. K-9 Portland, OR 97223	503-968-9225	503-598-7702	
<b>AGRI-CHECK, Inc.</b> 323 Sixth Street P.O. Box 1350 Umatilla, OR 97882	541-922-4894 Toll free: 800-537-1129		
<b>Agri-Test, Inc.</b> 2043 Kimberly Road P.O. Box 4 Twin Falls, ID 83303-0004	208-734-2303 Toll free: 800-632-0842		
<b>AmTest Inc</b> AmTest, Oregon, LLC 13035 SW Pacific Highway Portland, OR 97223	WA: 425-885-1664 OR: 503-639-9311		
<b>Analytical Sciences Laboratory, University of Idaho</b> Holm Research Center Moscow, ID 83844-2203	208-885-7081		
<b>Burdic Feed</b> 115 E. Willis St. Kent, WA 98032	253-852-2300	253-854-5074	<a href="http://www.burdicfeed.com/">http://www.burdicfeed.com/</a> <a href="mailto:burdic@aol.com">burdic@aol.com</a>
7710 Waller Rd. E. Tacoma, WA 98443	253-535-4325 Toll free: 800-953-2301		



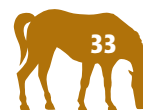

Resource/Address	Phone	Fax	Web Site/E-mail
<b>Cascade Analytical, Inc.</b> 3019 G.S. Center Rd. Wenatchee, WA 98801	509-662-1888		
<b>Central Analytical Lab, Oregon State University</b> 3079 Ag and Life Sci. Bldg. Corvallis, OR 97331-7306	503-737-2187		
<b>Columbia Analytical Service</b>	360-577-7222		
<b>Kuo Testing Laboratories, Inc.</b> 337 S. 1st Ave. Othello, WA 99344	509-488-0112	509-488-0118	<a href="http://www.kuotesting.com/">http://www.kuotesting.com/</a> <a href="mailto:kuotest@atnet.net">kuotest@atnet.net</a>
<b>Laucks Testing Laboratory</b> 940 South Harney St. Seattle, WA 98108	206-767-5060	206-767-5063	
<b>Northwest Agricultural Consultants</b> 2545 West Falls Kennewick, WA 99336	509-783-7450		
<b>Pacific Agricultural Laboratory</b> 12505 N.W. Cornell Rd. Portland, OR 97229	503-626-7943	503-641-0644	<a href="http://www.pacaglab.com">http://www.pacaglab.com</a> <a href="mailto:sthun@pacaglab.com">sthun@pacaglab.com</a>
<b>Soil &amp; Plant Laboratory, Inc.</b> P.O. Box 1648 Bellevue, WA 98009-1648 13547 SE 27th Place Ste. 3B Bellevue, WA 98005	425-746-6665	425-562-9531	<a href="mailto:splabnw@flash.net">splabnw@flash.net</a>
<b>Soil Search Labs</b> 42125 S Morton Rd. Kennewick, WA 99337	509-585-8875	509-586-0958	<a href="mailto:soilsrch@gte.net">soilsrch@gte.net</a>
<b>Soils Lab, University of Massachusetts</b>	413-545-2311		
<b>Soiltest Farm Consultants, Inc.</b> 2925 Driggs Dr. Moses Lake, WA 98837	509-765-1622 Toll free: 800-764-1622	509-765-0314	<a href="http://www.soiltestlab.com/">http://www.soiltestlab.com/</a> <a href="mailto:dan@soiltestlab.com">dan@soiltestlab.com</a>





Resource/Address	Phone	Fax	Web Site/E-mail
<b>Thurston Conservation District</b>	360-754-3588		
<b>Twiss Analytical Lab</b>	360-779-5141		
<b>William F. Black Soil Testing</b> 503 N. Gardner P.O. Box 317 Burlington, WA 98233	360-757-6112		
<b>Utah State University Analytical Labs</b> Ag Science Room 166 4830 Old Main Hill Logan, UT 84322-8530	435-797-2217		
<b>US Ag Analytical Services</b> 1320 E. Spokane St. Pasco, WA 99301	509-547-3838 Toll free: 800-244-0573 (509 area code)		

### Analytical Labs serving the Pacific Northwest

link to an Adobe Acrobat PDF

<http://cru.cahe.wsu.edu/CEPublications/eb1578e/eb1578e.pdf>

### Pasture Seed Sources

Check with the Whatcom Conservation District or Natural Resources Conservation Service for recommendations on seed mixes based on your location and needs. Many farmer’s co-ops and feed stores carry pasture seed—here are some additional suppliers:

Resource	Phone	Web Site/Address
Barenbrug USA	800-547-4101	<a href="http://www.barusa.com/">http://www.barusa.com/</a>
Farmlink	425-388-3311 ext. 2368	
Horseman’s Directory	425-881-8949	<a href="http://www.horsemans.net/">http://www.horsemans.net/</a>
J & S Progressive Seeds	360-354-1269	<a href="http://www.progressiveseeds.com/">http://www.progressiveseeds.com/</a>
Rainier Seeds	509-725-7015	<a href="http://www.rainierseeds.com/">http://www.rainierseeds.com/</a>
Rainier Seeds, Inc.	360-769-8113 360-769-8205	P.O. Box 1549 Port Orchard, WA 98366
Wolfkill	360-794-7065	



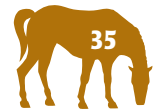

## Lime Sources

Resource/Address	Phone	Fax	Web site/E-mail
<b>Northern Lime Co. (Contact Larry Rygg)</b>			
440 Pease Rd. Burlington, WA 98233	360-757-3226	360-757-1934	<a href="http://www.northernlime.com">http://www.northernlime.com</a>
<b>Pace International</b>			
	Toll free: 800-345-5171		
<b>Hemphill Brothers (J.A. Jack)</b>			
Seattle, WA	206-762-7622		
<b>Wilbur-Ellis</b>			
Auburn, WA	253-351-6591 Toll free: 800-275-6920		

## Books and Publications on Weeds, Weed Control and Toxic Plants

The following can be purchased from the WSU Cooperative Extension Publications Office in Pullman, WA by calling 509-335-2857.

**2003 Pacific Northwest Weed Control Handbook.** WSU Cooperative Extension; published each year, contains most recent information on the type of herbicide to apply for each specific weed, how to handle it, and when to apply it.

**Weeds of the West.** 1991, Western United States Land Grant Universities Cooperative Extension Service. This is the definitive source for weed identification used for this area. Contains excellent photos and information on each plant, including whether they are toxic or not.

**Turf and Ornamental Weed Management** publication# MISC 0170 from WSU Cooperative Extension.

The following can be purchased through University Bookstore using the ISBN #.

**Weeds, Control Without Poison.** 1991, Walters. ISBN: 0-911311-25-4. Information on weed management without chemicals.

**Plants of the Pacific Northwest Coast.** 1994, Pojar and Mackinnon. ISBN: 1-55105-040-4. Contains excellent information and photo identification on most trees, shrubs, flowers and grasses of this area, including weeds. Includes information on toxic properties for each plant.

**Horse Owner's Field Guide to Toxic Plants.** 1996, Sandra Burger. ISBN: 0-914-327-62-3. Color photos of many of the plants toxic to horses common across North America.

For information on alternatives to chemicals like herbicides and pesticides, contact the Washington Toxic Coalition at 206-632-1545. They have a wonderful book available for purchase called Least Toxic Home Pest Control, by Dan Stein.





## Equipment Rentals

The following businesses may have equipment available for use on your farm.

Resource/Address	Phone	Fax	Web site
<b>Birch Equipment Rental &amp; Sales</b>			
1619 Kentucky St. Bellingham, WA 98226	360-734-5717		
8876 S. March Point Rd. Anacortes, WA 98221	360-293-7788		
2609 Old Hwy 99 S. Mount Vernon, WA 98273	360-428-7788		
<b>Hardware Sales, Inc.</b>			
2034 James St. Bellingham, WA 98225	360-734-6140	360-734-0069	<a href="http://www.hardware-sales.net/">http://www.hardware-sales.net/</a>
<b>Northwest Heavy Equipment Repair Inc.</b>			
122 Barrel Springs Rd. Alger, WA	360-724-4019		
<b>Master Rentals, Inc.</b>			
2219 James St. Bellingham, WA 98225	360-647-4508		
<b>Rental Service Corporation</b>			
3896 Irongate Rd. Bellingham, WA 98226	360-738-0298		<a href="http://www.rentalservice.com/">http://www.rentalservice.com/</a>
<b>Star Rentals</b>			
12505 Mukilteo Speedway Everett, WA	425-348-6969		<a href="http://www.starrentals.com/">http://www.starrentals.com/</a>
<b>United Rentals</b>			
2045 E. Bakerview Rd. Bellingham, WA 98226	360-647-7800	360-647-1599	<a href="http://www.unitedrentals.com/bharring@ur.com">http://www.unitedrentals.com/ bharring@ur.com</a>





## Web Sites Relating to Pasture Management

Web site	URL
BioControl	<a href="http://www.bio-control.com/">http://www.bio-control.com/</a>
USDA APHIS Plant Protection and Quarantine	<a href="http://www.aphis.usda.gov/ppq/weeds/weedhome.html">http://www.aphis.usda.gov/ppq/weeds/weedhome.html</a>
Rutgers Coop Ext. - Weeds	<a href="http://www.rce.rutgers.edu/weeddocuments/">http://www.rce.rutgers.edu/weeddocuments/</a>
Canada	<a href="http://www.agf.gov.bc.ca/croplive/cropprot/weeds.htm">http://www.agf.gov.bc.ca/croplive/cropprot/weeds.htm</a>
King County Noxious Weeds	<a href="http://splash.metrokc.gov/wlr/lands/weedid.htm">http://splash.metrokc.gov/wlr/lands/weedid.htm</a> <a href="http://splash.metrokc.gov/wlr/lands/noxious.htm">http://splash.metrokc.gov/wlr/lands/noxious.htm</a>
Soil Quality Institute (Test your own soil quality with a Soil Test Kit.)	<a href="http://www.statlab.iastate.edu/survey/SQI/sqihome.shtml">http://www.statlab.iastate.edu/survey/SQI/sqihome.shtml</a>

## Other Pasture Management Resources

*Dave Baker, pasture management specialist*

Phone: (360) 825-3560  
Address: Enumclaw  
E-mail: [Haybake@aol.com](mailto:Haybake@aol.com)





# ***Stream & Wetland Management***

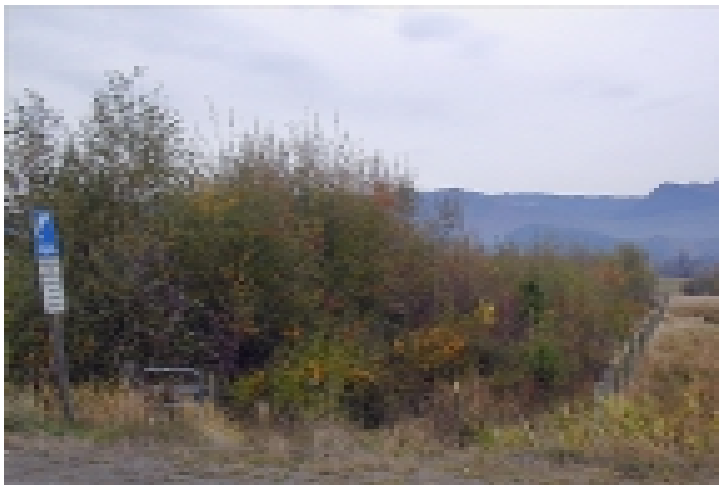

## **The Benefits of Stream and Wetland Protection**

### **Streams and Ditches**

If you have a stream, or even a ditch, running through your property, the way you manage your land has an especially large impact on water quality, aquatic life, and wildlife habitat. Many people don't realize that ditches are also an important part of the stream system; a significant amount of water enters streams through these waterways. Many farm ditches are old stream channels that still have fish living in them at some time during the year. Fish seek out ditches for protection and food during the rainy season.



## Wetlands: A Valuable Resource

Although they were once regarded as mucky swamps with little value, we now know that wetlands are a vital resource. Wetlands act like a giant sponge, soaking up water and slowly releasing it, reducing flooding and erosion. Wetlands also filter the water, removing pollutants as it passes through the vegetation. Since wetlands often connect to streams or groundwater sources, their ability to filter pollutants is important to water quality throughout the watershed. The water that soaks through wetlands often recharges aquifers, a source of water for many rural wells. Wetlands also provide important habitat for wildlife.

## The Importance of Vegetation Along Streams

Horses often spend a lot of time near their water source, and if their water source is a stream they can cause a lot of damage. Besides contaminating streams with manure and urine, horses will tend to overgraze these areas and trample the roots of trees and the plants living along the stream bank. The loss of vegetation leads to a muddy mess in winter but it also harms the environment in a number of ways:

- Trees and shrubs along streams provide shade and keep water temperatures cool. Fish need oxygen in the water to survive and when water temperatures rise, oxygen levels decrease—the warmer the water, the less oxygen there is. Warm water also leads to excessive growth of algae. Decaying algae use the oxygen fish need and turn water scummy and smelly.
- The roots of vegetation stabilize stream banks and prevent erosion. When soil erodes into streams, it can clog fish gills, cover spawning beds, smother fish eggs, and make it hard for fish to see their prey.
- Plants along stream banks help filter pollutants from manure and urine out of water before it reaches the stream. Nutrients from manure accelerate the growth of algae and even tiny amounts of ammonia from urine can be toxic to fish.
- Vegetation provides food, nesting, and hiding places for fish and wildlife such as turtles, beaver, river otter, eagles, frogs, and waterfowl.

## What You Can Do

### ✓ *Limit Horse Access To Streams and Wetlands*

- **Fencing horses out of streams** It is very important for the health of streams and wetlands to fence horses out of these areas completely or to at least limit access. The laws and ordinances regarding fencing issues and the buffer zones required will vary depending upon where you live and your specific situation. The Whatcom Conservation District is a great place to start for information. Check out the Resources section for additional contacts—some agencies may be able to provide you with or locate financial assistance for stream protection projects.
- **Provide alternate watering sources** Although horses can continue to drink from streams if you create watering points (usually created with a V or U formation of fence into the stream), a better alternative is off-stream watering. Water can be pumped or gravity fed to a stock tank placed away from the stream—no electricity required. Ram pumps use the force of the water coming downstream to pump





water into a holding reservoir. Pasture pumps use a hose that is operated by the horse and can pump water about 125 feet away from the stream and 25 feet uphill. Both systems are relatively inexpensive and pasture pumps can be moved up and down the stream *as needed*.

- **Do you have a wetland on your property?** Sometimes it can be difficult to tell if a portion of your property would be considered a wetland. Wetlands often remain soggy or have standing water during the driest months of the year—but not always. Wetlands may only stay soggy down in the plants’ root zones, which can be 12 inches below the surface of your pasture. One way to help you identify a wetland area is to look for plants that like to have their feet wet; areas with plants like skunk cabbage, cattails, and spirea are very likely to be wetlands. Areas with soft rushes, horsetail, and creeping buttercup may also be wetlands.
- **Protect when wet** When horses are allowed access to wet pastures they compact the soil, damage vegetation, and can destroy a wetland’s ability to act as a filter. Allowing horses to graze in wet areas will also eventually turn your green field into a muddy pasture. The end result is the loss of a valuable resource in exchange for a muddy mess that isn’t much use as a grazing area and is a breeding ground for insects and disease. To avoid this, keep horses off pastures whenever the soil is soggy—this may be for most or all of the year for wetland areas.

#### ✓ **Choose Confinement and Storage Areas With Care**

Locate confinement areas (such as paddocks or turn-out areas) and manure piles as far away as possible from wetlands, streams, and other waterbodies. Maintain a healthy section or “buffer strip” of grass or other vegetation downslope of confinement areas and manure storage areas. This buffer strip will help to filter out nutrients and sediments from water runoff before it reaches streams and wetlands. As with fencing, the buffer required by law will vary depending on where you live. But to give you an idea on what may be required, here are some commonly recommended separation distances between sensitive areas and manure piles or confinement areas:

<b>Sensitive Area</b>	<b>Minimum separation distance (feet)</b>
Property line	50 (ideal 500)
Residence or place of business	200 (ideal 2,000)
Private well or other potable water source	100
Wetlands or surface water (streams, ponds, lakes)	100
Drainage ditch or subsurface drainage pipe discharging to a natural water course	25
Water table (seasonal high)	3

(Source: [Field Guide to On-Farm Composting; Natural Resource, Agriculture, and Engineering Service](#))



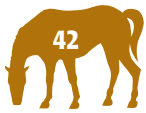

✓ *Restore Streamside Vegetation*

- **Let it grow, let it grow** A healthy stream bank will have a wide variety of native trees, shrubs, and groundcover lining its borders. But if the only vegetation you’ve ever seen near your streams is the grass that the horses have overgrazed, you may want to consider doing a little planting—but not until you’ve done some fencing! Native plants take very little maintenance, are naturally resistant to pests and disease, and provide great erosion control and habitat for wildlife.
- **Streamside plants** Following are a few trees, shrubs, and groundcovers that are especially adapted for stream banks and buffers. Because we do not have enough room to go into detail about which plants are best for your site and how and when to plant them, please see the Resources section for contacts, books, and websites that can provide you with more information.

<b>Trees</b>	<b>Preferred Conditions (sun vs. shade, dry vs. moist soils)</b>
Bigleaf maple	Sun/dry
Oregon ash	Sun/moist
Paper birch	Partial shade to sun/moist
Western hemlock	Shady/moist
Western red cedar	Shady/moist
Sitka spruce	Partial shade to sun/moist
Douglas fir	Sun/dry
Red alder	Partial shade to full sun/moist to wet
Grand fir	Sun/dry to moist

<b>Large shrubs &amp; small trees</b>	<b>Conditions</b>
Black hawthorn	Sun/moist
Evergreen huckleberry	Partial shade/dry
Oceanspray	Partial shade/dry
Red elderberry	Shade or sun/moist
Red osier dogwood	Shade or sun/moist



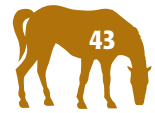

---

**Large shrubs & small trees (cont.)**    **Conditions**

---

Vine maple	Most conditions—as a sapling it must have shade to survive without water
Garry oak	Sun/dry
Pacific dogwood	Sun/moist
Serviceberry	Sun to partial shade/dry to moist

---

**Small shrubs**    **Conditions**

---

Tall Oregon grape	Sun to shade/moist to dry
Nootka rose	Sun/moist
Red flowering currant	Partial shade to sun/dry
Snowberry	Sun to partial shade/dry—tolerant of most conditions
Mock orange	Sun/dry
Indian plum	Sun to shade/dry to moist
Pacific ninebark	Sun to partial shade/moist

---

**Small plants & groundcovers**    **Conditions**

---

Bleeding heart	Sun to shade/moist
False lily-of-the-valley	Sun/moist
Kinnikinnick	Sun/dry
Salal	Partial shade to sun/dry

---





## Stream and Wetland Management Resources

### Regional Fisheries Enhancement Groups

There are twelve regional fisheries enhancement groups in Washington. They work together to educate and involve the public in salmon enhancement activities across the state at the community level. Technical and financial assistance may be available for projects related to salmon enhancement and preservation, e.g., stream fencing and bridges, stream planting, plant salvages, stream rehabilitation, and habitat repair

#### *Nooksack Salmon Enhancement Association*

Phone: 360-715-0283

Web site: <http://www.n-sea.org>

E-mail: [nsea@nas.com](mailto:nsea@nas.com)

#### *Skagit Fisheries Enhancement Group*

Phone: 360-336-0172

E-mail: [sfeg@skagitfisheries.org](mailto:sfeg@skagitfisheries.org)

Web site: <http://www.skagitfisheries.org/>

### Other Stream and Wetland Management Resources

#### *Whatcom Conservation District*

Phone: 360-354-2035

E-mail: [wcd@whatcomcd.org](mailto:wcd@whatcomcd.org)

Web site: <http://www.whatcomcd.org/>

#### *Kevin Fetterstrom, Wetlands Expert*

Wetlands delineation, ecological restoration, experience with horses and horse farms.

Phone: 206-442-1907

Address: Preston, WA

#### *Whatcom Land Trust*

The Trust assists landowners to preserve wildlife habitat, wetlands, agricultural and forest lands, and scenic open space and shorelines throughout Whatcom County.

Phone: 360-650-9470

E-mail: [info@whatcomland.com](mailto:info@whatcomland.com)

Web site: <http://www.whatcomlandtrust.org/>



# “Wild-Land” Management

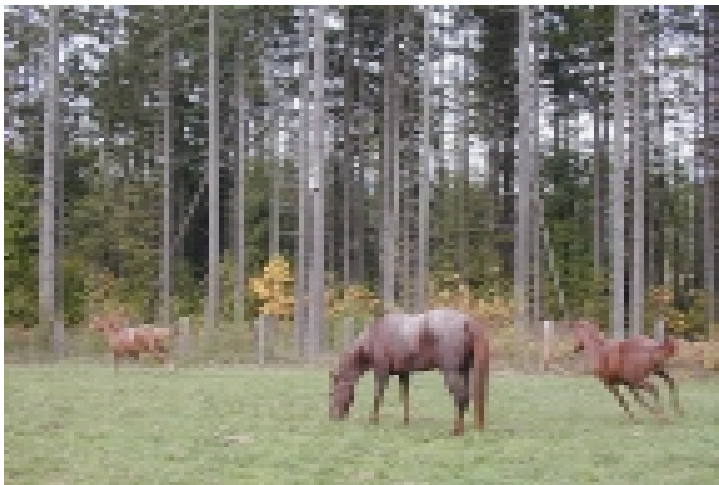

## Enhancing Your Horse Property for Wildlife

### The Benefits of Wildlife Enhancement

As the Puget Sound region becomes more and more developed, the natural open space that horse places provide can be an important haven for wildlife. Making your place wildlife-friendly can increase your enjoyment of the property and provide:

- **Natural pest control** By attracting insect-eating birds and using other natural pest controls, you can make a huge dent in the numbers of insects around your property. For example, one swallow consumes about 6,000 soft-bodied insects per day while bats can eat 600 mosquitoes an hour, more than 5,000 a night! Bats also eat agricultural pests such as corn borers, cutworm moths, potato beetles, and grasshoppers. By attracting hawks and owls, you'll also have a natural form of rodent control.
- **Low-cost, low-maintenance landscaping** Native plants are the best kind for wildlife and they also cost less money and require less maintenance than non-natives. Because they are suited to our climate and have developed natural resistance, they are much more disease tolerant and require less watering.

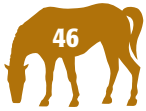

- **A renewable resource** Trees can provide you with a timber crop, firewood, wind breaks, dust barriers, shelter and shade for horses, mud control (since they soak up so much water), and a buffer between neighbors. When properly placed, trees can also help save on heating and cooling costs for your buildings. (Note: If you plan to log trees, wait until mid-July to help avoid disturbing nesting birds.)

## What You Can Do

### ✓ *Provide Habitat for the Wildlife You Want*

- **Water** Water is essential for all wildlife and can be supplied in a stock tank, birdbath, small pond, or a shallow dish. Simply placing a half-barrel under your roof downspout can do the job. Place a floating board as a “dock” in your water source to allow safe exit for birds or small animals. If you’re lucky enough to have a natural pond, stream, or wetland on your property, make sure to preserve or restore these areas. As discussed in the last section, fencing horses out of these areas is key.
- **Go native** Wildlife are better adapted to native plants and depend on them for food and shelter. A bonus for you is that since natives are better suited to our environment, they are more disease-resistant and require less watering and maintenance than non-natives. A few natives that attract birds, butterflies, and other wildlife are: beaked hazelnut, bitter cherry, black hawthorn, oregon grape, pacific crabapple, pacific serviceberry, red elderberry, red huckleberry, red osier dogwood, and salmonberry. See the Resources section for contacts that can give you more information on native plants.
- **Variety: the spice for wildlife** Provide a variety of vegetation types of varying heights, such as tall grasses, groundcovers, shrubs, and trees. The different heights and varieties of plants will provide habitat for the varying needs of birds and other wildlife. Make sure to include at least one good clump of evergreen trees and shrubs to provide year-round protective cover from weather and predators. Trees planted inside pastures and paddocks will probably need protection from chewing and root compaction. Fence off trees outside their drip zone—the area at the ends of the branches where raindrops roll off. Consider planting new trees where horses can’t reach them.
- **Pile up** When gathering downed branches from storms, stack them in a corner or unused area of your pasture. Brush piles make excellent homes for small mammals, amphibians, reptiles, and small birds. You can also create rock piles with the rocks removed from paddocks and pastures. If you have discarded short pieces of PVC pipe, place them at the bottom to create hiding spaces. Rock piles provide great habitat for toads, field mice, snakes, and weasels. Locate brush and rock piles away from any of your buildings to prevent these structures from becoming wildlife habitat!
- **Leave snags and downed trees** Woodpeckers, owls, chickadees, nuthatches, swallows, and wrens all use dead or dying trees (called “snags”) for nesting. Creatures such as salamanders and beneficial insects depend on downed trees in their lifecycle. Like brush and rock piles, keep dead trees away from your buildings to avoid attracting insects and rodents and for fire prevention.





- **Hedgerows** Plant shrubs or bushes along fence lines, in corners of pastures, along driveways, and in clumps in your pastures. Small animals and birds travel along these protected areas and use them for food and shelter. Native plants like hawthorn, serviceberry, oregon grape, and native roses can be planted to form good hedgerows.
- **Feeders and boxes** Hang bird feeders throughout your property—feeders can provide nectar for hummingbirds in the summer months and a variety of seed for other birds year round. Be sure to use the right type of food and nest boxes to attract the different species in your area. (It is also important to keep feeders clean and to empty bird nest boxes each fall.) Bat houses can be placed up high on a barn, pole, tree, or house. The best habitat for bats is within a half mile of a stream, lake, or wetland. It’s best to put bat houses up by early April—but be patient, it can take up to two years for a bat colony to find your box. If you are concerned about rabies carried by bats (or any wild, warm-blooded animal), consult your veterinarian for more information.

✓ **Eliminate Habitat for the Pests You Don’t Want**

Certain wildlife may not be as welcome around your horse property. To discourage unwanted visitors, eliminate their habitat.

- **Opossums** These non-natives can be the carriers of a disease that affects horses: Equine Protozoal Myelitis (EPM). To discourage opossums, raccoons, and coyotes put cat and dog food where pests can’t reach it, particularly at night. Also, don’t compost human food scraps (such as meat, fats, bones, or dairy products) in the manure compost pile. Even fruits and vegetables in an uncovered compost bin might become an attractant.
- **Rodents** Mice and rats can cause hundreds of dollars worth of damage per year in feed loss and structural damage. They can also carry very serious diseases for humans and livestock. Keep things picked up and put away in your barn to eliminate nesting areas and food supply. Items such as towels, horse blankets, and saddle pads should be stored in covered containers like trunks when not in use. Store feed in aluminum garbage cans with secure lids. Pick up cat and dog food and water at night and clean up any other feed or spilled grain. Having a mousing cat “on staff” in your barn can help with rodent control also.
- **Starlings** These non-native birds destroy nests and out-compete native species of birds. Like opossums, they are a possible carrier of the EPM disease. You can avoid starling problems with your bird boxes by having the holes made for the correct size of bird you want to attract. You can also attach “starling guards” on the roof of nest boxes. These aluminum pieces shield the opening and keep starlings from getting in or reaching inside. You can also buy bird feeders with guards that prevent larger birds like starlings from reaching the food.
- **Yellowjackets** These summertime pests can be discouraged by keeping garbage in tightly sealed containers and keeping kitchen scraps out of your manure pile.



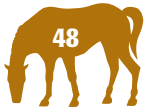

- **Deer and elk** Avoid planting certain types of trees, such as cedar, that attract deer. Protect young trees with fencing or wire cones, or simply plant more than you'll need and assume that some young trees will be lost to browsing. Try hanging clumps of human hair or soap in the trees where you want to repel deer. Investigate deer repellents—natural repellents like hot pepper sprays are reported to be quite effective. Check local garden centers, hardware stores, or garden supply catalogs.

### ✓ *Use Environmentally Friendly Insect Control*

Flies and insects can be a big problem around a horse place but chemical insecticides can end up harming more than the pest you're trying to eliminate. These chemicals can end up killing the good bugs and bug-eating birds that get rid of pests. Insecticides and pesticides can also cause harm if they are rinsed off by rainwater and carried into nearby streams and lakes. If you decide to use chemical pesticides, look for least-toxic varieties and always read and follow the directions carefully. We've already discussed some ways wildlife can help you combat insects, here are some other ways you can control insects naturally:

- **Eliminate habitat!** Practicing good manure management (like picking up manure regularly and covering your manure pile) and taking steps to eliminate mud on your property will help significantly in reducing breeding grounds for insects.
- **The good, the bad, and the well, they're all ugly** Fortunately, there are some good bugs out there that will help you fight the bad guys. Fly parasites are gnat-sized, nocturnal wasps that lay their eggs in the developing pupae of flies. The eggs of the parasite then hatch into larvae and feed on the inside of the pupae. One fly parasite can destroy as many as 50 fly pupae! Fly parasites do not harm humans or animals in any way—in fact, you won't even notice their presence but they can be extremely effective in reducing and nearly eliminating the fly population. For best results, release the parasites in spring before the fly population becomes a problem. There are many companies that sell fly parasites.

*For more information, see the Resources section for some suppliers or look for ads in horse magazines and in farm supply catalogs. Local garden stores may also carry them.*

- **Birds and bats** As mentioned earlier, encouraging birds and bats onto your property can do wonders for reducing insect populations.
- **Traps** Several types of insect traps can be useful for reducing the flying insect population. One of the cheapest and easiest is flypaper or tape. Pheromone traps are jars with one-way lids that can be placed in barn areas. The traps contain pheromone solution, a natural substance that attracts flies. Lured into the trap by the pheromones, the flies and yellowjackets are trapped and die. Traps are sold by different companies under names like Trap-A-Fly, Venus FlyTrap, and Fly Terminator. Check farm and horse supply catalogs.
- **Physical controls** If you've still got flies around, fly masks can help keep horses comfortable. For horses that have allergies to culicoides ("no-see-ums"), try putting a fan in their stall—the air current will be too strong for no-see-ums to fly through.



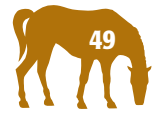

## Wildlife Enhancement Resources

### Books on Native Plants & Wildlife Enhancement

**America’s Neighborhood Bats**, by Merlin D. Tuttle, ISBN 0-292-70403-8

**Plants of the Pacific Northwest Coast**, by Pojar & MacKinnon

**Gardening with Native Plants of the Pacific Northwest**, by Arthur Kruckeberg

**Northwest Trees**, by Arno & Hammerly

**Noah’s Garden**, restoring the ecology of our own back yards, by Sara Stein

**The Original Birdhouse Book**, by Don McNeil

**Landscaping for Wildlife in the Pacific Northwest**, by Russel Link

**Horse Owner’s Field Guide to Toxic Plants**, by Sandra Burger

**Birds of North America**, by National Geographic Society

### Fly Parasite Suppliers

Resource	Phone
Kunafin	800-832-1113
Farnam Equipment Co.	800-267-5211
Arbico	800-827-2847
Spalding Labs	800-845-2847

### Fly Masks, Fly Traps and Other Insect Controls Sources

Also, check local feed and tack stores

Resource	Phone
Jeffers Equine catalogue	800-533-3377
Stateline Tack catalogue	800-228-9208
American Livestock Supply catalogue	800-356-0700
Valley Vet Supply catalogue	800-356-1005





## Nest Box Sources

Resource/Address	Phone	Web site/E-mail	Supplies
<b>Wild Bird Chalet</b> 705 Kentucky St. Bellingham, WA	360-734-0969		Nest boxes, bat boxes, feeders, and other wild bird supplies.
<b>Backyard Wings and Water</b> P.O. Box 1903 Frederick, MD 21702	301-668-2999 877-840-3781	<a href="http://www.wingsandwater.com/">http://www.wingsandwater.com/</a> <a href="mailto:rrc@wingsandwater.com">rrc@wingsandwater.com</a>	Nest boxes for swallows, bluebirds, wrens, others; Mason Bee boxes; feeders; misters & drippers; other outdoor enhancements

## More Information on Bats and Bat Houses and Suppliers

Check gardening supply catalogues and stores, local feed stores and wild bird supply stores for other resources besides those listed here.

Resource/Address	Phone	Web site/E-mail	Information
<b>Bat Conservation International</b> P.O. Box 162603 Austin, TX 78716		<a href="http://www.batcon.org/">http://www.batcon.org/</a>	
<b>Real Goods</b>	800-762-7325		Catalog carries bat houses
<b>Missouri Department of Conservation</b> P.O. Box 180 Jefferson City, MO 65102			A blueprint for the "Missouri-style" bat house, a house for large colonies
<b>Whatcom County Cooperative Extension</b>	360-676-6736	<a href="http://whatcom.wsu.edu/">http://whatcom.wsu.edu/</a> <a href="mailto:whatcom@wsu.edu">whatcom@wsu.edu</a>	
<b>Bats Northwest</b>	206-256-0406	<a href="http://www.batsnorthwest.org/">http://www.batsnorthwest.org/</a>	In Washington contact for questions and information on bats.



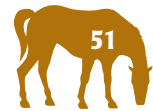

## Other Wildlife Agency and Organizations

Resource/Address	Phone	Web site/E-mail
<b>North Cascades Audubon Society</b>		
		<a href="http://www.northcascadesaudubon.org/">http://www.northcascadesaudubon.org/</a> <a href="mailto:info@northcascadesaudubon.org">info@northcascadesaudubon.org</a>
For over 30 years, the North Cascades Audubon Society has represented the interests and importance of wildlife, habitat and the environment in Whatcom County. Through scientific research, environmental education, stewardship and advocacy, NCAS provides a variety of services and opportunities for members and the public to engage with the natural world.		
<b>Natural Resources Conservation Service</b>		
		<a href="http://www.nhq.nrcs.usda.gov/CCS/WildHab.html">http://www.nhq.nrcs.usda.gov/CCS/WildHab.html</a>
Information on preserving backyard wildlife habitat		
<b>National Association of Conservation Districts</b>		
		<a href="http://www.nacdnet.org/pubaff/backyard.htm">http://www.nacdnet.org/pubaff/backyard.htm</a>
Information on preserving backyard wildlife habitat		
<b>Washington Toxics Coalition</b>		
	206-632-1545	<a href="http://www.watoxics.org/">http://www.watoxics.org/</a>
This non-profit organization produces a wide variety of publications on alternatives to toxic chemicals in products such as fertilizers, pesticides, and herbicides, including <u>Least Toxic Home Pest Control</u> , by Dan Stein.		
<b>Wolf Haven</b>		
	800-448-9653	<a href="http://www.wolfhaven.org/">http://www.wolfhaven.org/</a>
For questions on coyotes.		
<b>Washington Department of Fish and Wildlife</b>		
	425-775-1311	<a href="http://www.wa.gov/wdfw/">http://www.wa.gov/wdfw/</a>
For information on the Backyard Wildlife Program (see WDFW reference above for more information) as well as for questions on bears, bobcats, or cougars.		





# ***Your Horses and the Law***



We hope that this manual has provided you with practical steps that will help you to protect water quality *and* the health of your horses. Because all of our actions put together add up to a large impact on our water, there are rules and regulations that have been established to minimize the negative impact we have on the environment. It is easier and less costly to prevent pollution than to try to clean it up. And it is easier not to pollute than to be faced with an enforcement action.

Recent shellfish bed closures in the region and the listing of Chinook salmon and bull trout as threatened species under the federal Endangered Species Act, are just a couple of indications that our lands and waterbodies need our protection. Below are some laws and ordinances that may affect you and your horse property. See the Resources section for contacts who can provide you with more information on the specific rules and regulations in your area.

### *The Washington State Water Pollution Control Act (RCW 90.48)*

Prohibits the discharge of pollutants to the storm drainage system, surface waters (including streams, lakes, rivers), and groundwater. This prohibition applies not only to pollutants dumped *directly* into surface waters or down storm drains (*italics added*); it is also against the law to allow pollutants to be washed into surface water or seep into groundwater. Although state enforcement staff seek to work cooperatively with violators to prevent pollution, they can issue fines for up to \$10,000 per day per violation. The Department of Ecology enforces the Washington State Water Pollution Control Act.

Many counties and cities in Washington have enacted or are in the process of enacting some form of livestock management ordinance. Such ordinances are meant to encourage livestock management that reduces the adverse impacts of livestock on the environment, particularly impacts on water quality and salmon habitat. These ordinances call for the completion of farm plans and implementation of best management practices that protect the environment from the impacts of livestock.

*For more information about technical assistance and small farm planning within Whatcom County, please contact the Whatcom Conservation District at 360-354-2035 ext. 3.*

Most counties have what is called a **critical areas ordinance**. This ordinance regulates land use activities within environmentally sensitive areas such as streams, steep slopes, wetlands and associated buffers. The purpose of regulating land use activities within environmentally sensitive areas is to minimize the risk of water quality degradation, landslides, erosion, flooding, and damage to public and private property. Only with county approval, can work within these areas take place.

*For more information regarding critical areas identification and permit requirements, please contact Whatcom County Planning and Development Services at 360-676-6907.*



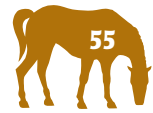

Before you clear any land—even just to remove trees for a new pasture or grade dirt for an arena. With very few exceptions, any clearing or grading requires a **clearing and grading permit**.

*For more information regarding restrictions and permit requirements, please contact Whatcom County Planning and Development Services at 360-676-6907.*

Contact your city or county Health Department for information on **wellhead protection** and **caring for your septic system**. Their recommendations can help prevent mistakes like storing manure too closely to a wellhead or allowing horses to graze on top of a septic drainfield—actions that can cause contamination of drinking water and damage to your septic system.

*For more information, please contact Whatcom County Health & Human Services at 360-676-7646.*

State and local law regulates the **transport of manure** and the **selling of compost**.

*For more information on how these regulations affect you., please contact the Whatcom Conservation District at 360-354-2035.*

A **water use permit** is required before diverting, impounding, or withdrawing any surface water (or groundwater) if used to irrigate a lawn or non-commercial garden more than  $\frac{1}{2}$  acre in size or if the withdrawal equals or exceeds 5,000 gallons per day.

*For more information , contact the Bellingham Field Office of the Washington Department of Ecology at 360-738-6250.*

A written **Hydraulic Permit Approval** may be required if you are doing work, construction, development, or other activities that will use, divert, obstruct, or change the natural flow or bed of any fresh or salt waterbody. This permit is also needed when discharging water from gutters into streams and wetlands.

*To learn more, contact the Washington Department of Fish and Wildlife at 360-902-2200.*

You may need a **Forest Practice Approval** for practices including harvesting, reforestation, road building, fertilizing, preventing and suppressing diseases and insects, salvaging trees, controlling brush, and applying chemicals.

*For more information , contact the Washington Department of Natural Resources at 360-856-3500 or toll free at 800-527-3305.*





# *Resources*



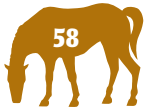

## Local Agencies and Organizations Offering Education and Technical Assistance

Please note that the following resources are targeted towards Whatcom County. The list of businesses and agencies in this section is not comprehensive. Prices and policies are subject to change. The inclusion of an organization or business as a resource does not constitute an endorsement by the authors or funding agencies.

### *Whatcom Conservation District*

Whatcom Conservation District provides technical assistance, demonstration projects, educational handouts, classes, and workshops on livestock and water quality issues. It can provide you with information on many aspects of manure management, mud management, pasture management, stream restoration projects, fencing, and improving wildlife habitat. It can also help you develop a farm plan. A farm plan can help you meet your goals for your property while protecting water quality and natural resources. Farm plans consider farm size, soil types, slope of the land, proximity to streams or waterways, and resources such as machinery or buildings and finances available. Whatcom CD may be able to help fund (or help you find funding) for certain types of livestock management and water quality improvements, including fencing along streams, animal watering stations, and bank stabilization. Whatcom CD also holds a yearly tree sale where you can order low-cost native trees and shrubs.

Address: 6975 Hannegan Rd.  
Lynden, WA 98264

Phone: 360-354-2035

Fax: 360-354-4678

Web site: <http://www.whatcomcd.org/>

E-mail: [wcd@whatcomcd.org](mailto:wcd@whatcomcd.org)

### *Washington State University Cooperative Extension Whatcom County*

Each county in Washington has a WSU Cooperative Extension office. The Cooperative Extension provides a wide variety of educational materials and programs on livestock and water quality issues. It administers many educational programs such as the Livestock Advisors and Master Gardener programs, 4-H Youth Education, and forest and watershed stewardship classes. The Livestock Advisor class series covers topics including health and general care, behavior, mud and manure management, weeds, pasture management, nutrition, hoof care, animal handling, regulations and responsibilities.

Address: 1000 N. Forest Street, Suite 201  
Bellingham WA, 98225

Phone: 360-676-6736

Fax: 360-738-2458

Web site: <http://whatcom.wsu.edu/>

E-mail: [whatcom@wsu.edu](mailto:whatcom@wsu.edu)



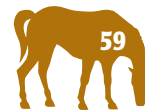

### *Whatcom Master Composter Program*

Participants learn about waste prevention, recycling, home composting, and hazardous waste. Training includes approximately 40 hours of classroom sessions, field demonstrations, and hands-on activities. In return for the training, Master Recycler Composters agree to share their knowledge and skills with others by volunteering 40 hours of community outreach.

Address: 1000 N. Forest Street, Suite 201  
Bellingham WA, 98225

Phone: 360-676-6736

Fax: 360-738-2458

Web site: <http://whatcom.wsu.edu/ag/compost/mrcprogram.htm>

For information on composting horse manure: <http://whatcom.wsu.edu/ag/compost/horsecompost.htm>

E-mail: [whatcom@wsu.edu](mailto:whatcom@wsu.edu)

### *Noxious Weed Control Board*

Whatcom county's Noxious Weed Control Board can provide you with information on identifying and controlling noxious weeds.

Address: Noxious Weed Control Board  
Whatcom County Public Works  
901 W. Smith Road  
Bellingham, WA

Phone: 360-354-3990

Web site: <http://www.co.whatcom.wa.us/pubwks/noxious/noxious.htm>

To download an Adobe Acrobat PDF of a noxious weed list, check out the following link:

<http://www.co.whatcom.wa.us/pubwks/noxious/list99/list2002.pdf>

For Adobe Acrobat PDF Fact Sheets describing some of the most problematic weeds in our area, visit this link:

<http://www.co.whatcom.wa.us/pubwks/noxious/factsheets/factsheets.htm>

E-mail: [Noxious\\_Weeds@co.whatcom.wa.us](mailto:Noxious_Weeds@co.whatcom.wa.us)

### *Whatcom County Planning and Development Services*

For information on permits needed for any clearing or grading you plan to do on your property—especially within wetlands, along the edges of lakes or streams, on steep slopes or within the buffer zones of all these sensitive areas—consult your county's planning and development department. In incorporated areas, contact your city for referral to the appropriate department.

Address: 5280 Northwest Rd.  
Bellingham, WA 98227

Phone: 360-676-6907

Web site: <http://http://www.co.whatcom.wa.us/PDS/home.htm>

Email: [pds@co.whatcom.wa.us](mailto:pds@co.whatcom.wa.us)



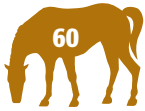

### *Whatcom County Health Department*

Contact your county's health department for information on wellhead protection, well water testing, and caring for you septic system.

Address: 509 Girard St.  
Bellingham, WA 98225

Phone: 360-676-6720

Web site: <http://www.co.whatcom.wa.us/Health/home.htm> E-mail: [health@co.whatcom.wa.us](mailto:health@co.whatcom.wa.us)

### *USDA Natural Resources Conservation Service*

The USDA Natural Resources Conservation Service (NRCS) supports the efforts of the Conservation Districts and provides many of the same technical services. NRCS field offices are in each county to provide local technical assistance.

Address: Lynden Service Center  
6975 Hannegan Rd.  
Lynden, WA 98264-9019

Phone: 360-354-5658, 360-354-2035 Fax: 360-354-4678

Web site: National: <http://www.nrcs.usda.gov/>  
State: <http://www.wa.nrcs.usda.gov/>

### *Koma Kulshan Chapter of Washington Native Plant Society*

Contact the local chapter or consult the Washington Native Plant Society web site for information on planting and caring for native plants.

President: Vikki Jackson, 360-734-9484

Field Trip Chair: Barry Wendling, 360-671-8403

Address: 2636 Franklin St.  
Bellingham, WA 98225

Web site: <http://www.wnps.org/> E-mail: [ledum1@attbi.com](mailto:ledum1@attbi.com)

### *Whatcom County Agricultural Guide*

Farm Friends is an organization whose goals include promoting public awareness of farming and agriculture to the greater community through education. They are dedicated to restoring the critical link between our community and its food supply. Whatcom County Agriculture Preservation Committee represents the entire farm community in its struggles with water rights, protection for both the farmer and farmland and strives to be the united voice of Whatcom County's farmers in challenges they face. Our goals include restoring and maintaining a dynamic, healthy and sustainable farm future for our county.

Address: 1796 Front St.  
Lynden, WA 98246

Phone: 360-354-1337 Fax: 360-354-0948

Web site: <http://www.whatcomfarm.org/> E-mail: [wcfarmfriends@aol.com](mailto:wcfarmfriends@aol.com) or [wcaapres@aol.com](mailto:wcaapres@aol.com)



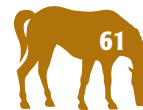

### **Whatcom County Farm Service Agency**

The US Department of Agriculture's Farm Service Agency (FSA) works in cooperation with local Natural Resources Conservation Service offices and Conservation Districts to administer conservation programs. The FSA administers the Conservation Reserve Enhancement Program (CREP) which provides technical and financial assistance to qualifying landowners to install and maintain streamside buffers. The CREP program compensates landowners for being good land stewards by providing cost-sharing for developing riparian buffers (e.g., installing fences and animal watering stations, planting trees, etc.) as well as providing annual payments.

For more information and to receive a free, no-obligation evaluation of your land, contact your local Conservation District or Natural Resources Conservation Service.

Address: FSA Service Center Office  
Whatcom County Farm Service Agency  
6975 Hannegan Rd.  
Lynden, WA 98264-9019

Phone: 360-354-5658

Fax: 360-354-4678

Web site: <http://www.fsa.usda.gov/> (National)  
<http://www.fsa.usda.gov/WA/> (State)

## **Whatcom County Agencies Offering Education and Technical Assistance**

### **County Government Web Site**

Web site: <http://www.co.whatcom.wa.us/>

### **Whatcom Conservation District**

Address: 6975 Hannegan Rd.  
Lynden, WA 98264

Phone: 360-354-2035

Fax: 360-354-4678

Web site: <http://www.whatcomcd.org/>

E-mail: [wcd@whatcomcd.org](mailto:wcd@whatcomcd.org)

### **WSU Cooperative Extension**

Phone: 360-676-6736

Web site: <http://whatcom.wsu.edu/>

E-mail: [whatcom@wsu.edu](mailto:whatcom@wsu.edu)

### **Master Recycler Composter Training Program**

WSU Cooperative Extension

Phone: 360-676-6736

### **Noxious Weed Control Program**

Address: Noxious Weed Control Board  
Whatcom County Public Works  
901 W. Smith Road  
Bellingham, WA

Phone: 360-354-3990

Web site: <http://www.co.whatcom.wa.us/pubwks/noxious/noxious.htm>

E-mail: [Noxious\\_Weeds@co.whatcom.wa.us](mailto:Noxious_Weeds@co.whatcom.wa.us)





### ***Whatcom County Planning and Development Services (Permit information)***

Address: 5280 Northwest Rd.  
Bellingham, WA 98227

Phone: 360-676-6907

Web site: <http://http://www.co.whatcom.wa.us/PDS/home.htm> Email: [pds@co.whatcom.wa.us](mailto:pds@co.whatcom.wa.us)

### ***Whatcom County Health Department (Drinking water and septic system information)***

Address: 509 Girard St.  
Bellingham, WA 98225

Phone: 360-676-6720

Web site: <http://www.co.whatcom.wa.us/Health/home.htm> E-mail: [health@co.whatcom.wa.us](mailto:health@co.whatcom.wa.us)

### ***USDA Natural Resources Conservation Service***

Address: Lynden Service Center  
6975 Hannegan Rd.  
Lynden, WA 98264-9019

Phone: 360-354-5658, 360-354-2035 Fax: 360-354-4678

Web site: National: <http://www.nrcs.usda.gov/>  
State: <http://www.wa.nrcs.usda.gov/>

### ***Washington Native Plant Society, Koma Kulshan Chapter***

Address: 2636 Franklin St.  
Bellingham, WA 98225

Web site: <http://www.wnps.org/> E-mail: [ledum1@attbi.com](mailto:ledum1@attbi.com)

## **Regional Agencies and Organizations Offering Education and Technical Assistance**

### ***Puget Sound Water Quality Action Team (PSWQAT)***

PSWQAT develops plans and programs to further environmental advocacy by working to encourage governments, businesses, organizations, and individuals to join together as stewards of the ecosystem. PSWQAT implements programs through state and local agencies involving education, financial, and technical assistance.

Address: Puget Sound Action Team, Office of the Governor  
P.O. Box 40900  
Olympia, WA 98504-0900

Phone: 800-54-SOUND (Toll-free inside Washington only)  
360-407-7300 (Outside Washington)

Web site: <http://www.wa.gov/pswqat/>



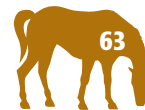

### *Washington State Conservation Commission*

The Commission provides leadership, partnerships, and resources to support locally governed conservation districts. The Commission administers grants for conservation projects, assists with audits, and guides conservation districts' procedures and operations.

Web site: <http://www.conserver.org/>

E-mail: [wcc@conserver.org](mailto:wcc@conserver.org)

### *Washington State Department of Agriculture (WSDA)*

The WSDA supports the agricultural community and promotes consumer and environmental protection.

Address: 1111 Washington Street S.E.  
P.O. Box 42560  
Olympia, WA 98504-2560

Phone: 360-902-1800, 360-902-1996 (TDD)

Web site: <http://www.wa.gov/agr/>

E-mail: [poffice@agr.wa.gov](mailto:poffice@agr.wa.gov)

### *Washington Department of Ecology*

The mission of the Department of Ecology is to protect, preserve, and enhance Washington's environment, and promote the wise management of our air, land, and water. The Department of Ecology administers state water quality regulations and permits; provides technical assistance and oversight to local governments in administration of the Shoreline Management Act, in management of wetlands, non-point source pollution and stormwater; and approves local groundwater management.

Address: P.O. Box 47600  
Olympia, WA 98504-7600

Phone: 425-649-7000 (Northwest Regional Office)  
360-738-6250 (Bellingham Field Office)

Web site <http://www.ecy.wa.gov/>

### *Washington Department of Fish and Wildlife*

The WDFW **Backyard Wildlife Program** offers a package of specific information for creating wildlife habitat in our state. Send a \$5 check payable to "WDFW" to: Washington Dept. of Fish and Wildlife, Backyard Sanctuary Program, 16018 Mill Creek Blvd, Mill Creek, WA 98012. Be sure and include your address with your request. Contact for questions or problems with bears, bobcats, or cougars.

Address: 600 Capitol Way N.  
Olympia, WA 98501-1091

Phone: 360-902-2200, 360-902-2207 (TDD) Fax: 360-902-2230

Web site: <http://www.wa.gov/wdfw/>



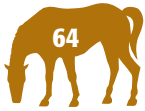

### *Horses for Clean Water*

A program run and supported by horse owners promoting environmentally sensitive horsekeeping; offering classes, workshops, farm tours and materials development on topics such as pasture, manure and mud management; available for individual farm consultations.

Address: 17717 252nd Ave. S.E.  
Maple Valley, WA 98038

Phone: 425-432-6116

Web site: <http://www.horsesforcleanwater.com/> E-mail: [ARBlickle@aol.com](mailto:ARBlickle@aol.com)

### **Other General Resources**

#### *National Horseman's Directory*

A free publication that is the "yellow pages" for horse businesses and all things horsey for the Pacific Northwest.

Address: Kannberg & Associates  
15311 N.E. 90th St.  
Redmond, WA 98052

Phone: 425-881-8949, 800-735-7258

Fax: 425-881-9803

Web site: <http://www.horsemans.net/>

E-mail: [info@horsemans.net](mailto:info@horsemans.net)



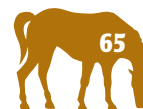

## Whatcom County Feed Stores

Resource/Address	Phone	Resource/Address	Phone
<b>Cenex-Whatcom Farmers Co-op</b> 3500 Meridian St. Bellingham, WA	360-734-4010	<b>Portal Way Farm &amp; Garden</b> P.O. Box 639 Ferndale, WA 98248	360-384-3688
<b>Kelly Ridge Farms</b> 366 E Kelly Rd. Bellingham, WA 98226	360-398-8578	<b>Bogaard Hay Co.</b> 1718 Main St. Lynden, WA	360-354-5674
<b>Laurel Farm Supply</b> 325 West Laurel Rd. Bellingham, WA 98226	360-398-1216	<b>Elenbaas Co.</b> 421 Lynden-Birch Bay Rd. Lynden, WA	360-354-3300
<b>Mt.. Baker Feed</b> 3170 E Smith Rd. Bellingham, WA 98226	360-592-0109	<b>Lynden Farm &amp; Garden</b> 309 Walnut St. Lynden, WA 98264	360-354-5611
<b>Wild Bird Chalet Etc.</b> 705 Kentucky St. Bellingham, WA 98225	360-734-0969	<b>Westlyn Farm &amp; Pet</b> 421 Birch Bay-Lynden Rd. Lynden, WA, 98264	360-354-3300
<b>Wild Bird Crossing</b> 1155 E Sunset Dr. Bellingham, WA 98226	360-738-7088	<b>Whatcom Farmers Co-op</b> P.O. Box 611 Lynden, WA 98264	360-354-2108
<b>Elenbaas Co.</b> 302 W. Main St. Everson, WA	360-966-3352		





# Index

## A

Aerated Static Pile Method .....	7
aerating .....	28
aeration system .....	7
Aerator .....	28
algae .....	40
ammonia .....	40
aquifer .....	40

## B

backyard composting system .....	9
bacteria .....	vi, 4, 17
bats .....	45, 48
bedding .....	2, 4–5, 7–8, 10
belting .....	20
birds .....	46–48
bird boxes .....	47
bird feeders .....	47
birdbath .....	46
bloodmeal .....	4, 8
boxes .....	47
buffer .....	3, 24, 42, 46
buffer strip .....	3, 41
buffer zone .....	3
bug .....	48
bugs .....	5
building .....	5, 46
building the bins .....	6
bushes .....	47
butterflies .....	46

## C

carbon .....	4, 8
carpenter's level .....	6
cat .....	47
cattail .....	41
cement .....	3
cement pad .....	9
chain link fence .....	28
chain saw .....	6
chemicals .....	29, 48
chicken manure .....	7, 8
colic .....	17, 19, 23
compact .....	21, 24
compost .....	2, 4–5, 7–8, 11–12, 20, 27–28, 47
compost pile .....	8
compost thermometer .....	5. <i>See also</i> composting
composting .....	v, 4–6, 9–11
<i>See also</i> compost	
composting system .....	6, 9, 11
concrete .....	26
confinement area .....	20, 41
Conservation District ..	3, 7, 21, 28–29, 40
contaminant .....	21

contamination .....	21–22
Cooperative Extension .....	8, 14, 29
corral .....	18, 24
cottonwood .....	22
covering .....	6
coyote .....	47
creeping buttercup .....	41
culicoides .....	17, 48

## D

deck screws .....	6
deer .....	48
deworming .....	10
disease .....	5, 17, 23, 42, 45, 47
disposal plan .....	10
ditch(es) .....	3, 6, 22, 24, 39, 41
dog .....	47
douglas fir .....	22
downspouts .....	20
dragging .....	28–29
drainfield .....	26
drill .....	6
drip zones .....	22
dry wells .....	21
dryer felt .....	20
dump truck .....	9

## E

electric tape .....	25
elk .....	48
equipment .....	6, 8, 10–11, 25, 27

## F

feed .....	23
feeders .....	47
fence .....	22, 46
fencing .....	21, 26–27, 40, 42, 46, 48
fertilizer .....	4, 7–8, 10, 27–28
fertilizing .....	29
filter fabric .....	20
filth flies .....	17
fish .....	vi, 21, 39
flies .....	4, 48
fly larvae .....	5, 10
fly parasites .....	48
footing .....	19–20, 24
french drain .....	21
fruit trees .....	22, 29
fungi .....	5

## G

garbage cans .....	27
garden hose .....	5
garden tractor .....	9

grass .....	4, 7–9, 18, 23–24, 28–29, 46
grass clippings .....	8
grass seed .....	28
gravel .....	3, 19, 21
grazing .....	27
groundcover .....	42, 46
groundwater .....	vi, 3
growing season .....	8
gutters .....	20

## H

hand saw .....	6
harrow .....	27, 28
herbicide(s) .....	29
hogfuel .....	19, 20
horsetail .....	41
hot wire .....	21, 25
hybrid poplars .....	22

## I

insect control .....	48. <i>See also</i> insects
insecticide .....	48
insects .....	2, 18, 23, 45, 48

## L

lake .....	vi, 18, 23, 41, 47
landscape timbers .....	6
landscaping plants .....	29
large backhoe .....	9
large shrubs .....	42, 43
larvae .....	48
law(s) .....	40, 53. <i>See also</i> ordinance(s)
lawn .....	24
lawnmower .....	7, 24
Livestock Ordinance .....	v

## M

manure .....	vi–vii, 1, 3, 6–8, 10–11, 13, 15, 18–19, 21, 23, 27–28, 40–41, 47
manure composting system .....	5.
<i>See also</i> manure	
manure spreader .....	7, 27, 28
mats .....	20
mice .....	47
microorganisms .....	4
moisture .....	19
mosquitoes .....	17
mowing .....	29
mud .....	v–vi, 1, 3, 17, 19–20, 22–23, 28, 40, 46, 48
mulch .....	8
mulching mower .....	27



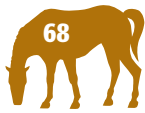

**N**

native plants ..... 42, 46, 47  
 native trees ..... 42  
 Natural Resources Conservation  
   Service ..... 3, 7, 8, 21, 29, 34  
 nest boxes ..... 47  
 New Zealand style fencing .... 26. *See also*  
   fencing  
 newspaper bedding ..... 2  
 nitrate ..... vi  
 nitrogen ..... 4, 7–8, 10, 19  
 nutrient(s) ..... vi, 3, 6–7, 9, 14, 18,  
   22–23, 28, 40–41

**O**

odors ..... vi, 2, 4  
 opossums ..... 47  
 ordinance ..... 40. *See also* laws  
 organic matter ..... 4  
 organisms ..... 5, 7  
 ornamental landscaping trees ..... 22  
 overgraze ..... 21  
 overseeding ..... 29  
 oxygen ..... vi, 4, 40

**P**

paddock(s) ..... 3, 18, 24, 26, 41, 46  
 parasite ..... vi, 6, 18  
 pasture management ..... 18, 25, 29  
 pasture pump ..... 41  
 pasture(s) .... v, vii, 7, 9–10, 18, 20, 22–24,  
   26, 29, 37, 41, 46  
 pathogens ..... 4–5, 10, 17  
 pen ..... 18, 24  
 pesticide(s) ..... 48  
 pests ..... 42, 45, 47  
 phosphorous ..... 4  
 pickup truck ..... 8, 28  
 planning ..... 6  
 plant(s) ..... 40–41, 48  
 plastic ..... 26  
   plastic sheet ..... 6  
 pollutant ..... vi, 2, 18, 23, 40  
 pollution ..... v–vi, 1, 3  
 pond ..... 41, 46  
 portable electric fencing ..... 26.  
   *See also* fencing  
 post hole digger ..... 6  
 potassium ..... 4  
 protozoa ..... 5  
 pupae ..... 48  
 PVC pipe ..... 6–7, 21, 46

**R**

raccoons ..... 47  
 rain ..... 8, 24  
   rain barrel ..... 21  
   rainwater ..... v–vi, 2, 6, 18–19, 21, 48  
 ram pumps ..... 40  
 rats ..... 47  
 red osier dogwood ..... 22  
 regulation(s). *See* law(s): ordinance(s).  
 renovating ..... 29  
 repellent ..... 48  
 riding lawnmower ..... 7, 27–28  
 rodent(s), rodent control ..... 45–47  
 roof ..... 6, 22  
 roots ..... 40  
 rotational grazing system ... 18, 24, 26, 29  
 rubber stall mats ..... 2, 20

**S**

sacrifice area(s) ..... 18, 21–22, 24, 25  
 salmon ..... 18  
 sand ..... 19  
 screwdriver ..... 6  
 sediments ..... vi, 41  
 seed spreaders ..... 27  
 seeds ..... 34  
 septic system ..... 26  
 shade ..... 26  
 shavings ..... 2, 7–8  
 shellfish ..... 21  
 shelter ..... 26  
 shovel ..... 7, 19, 28  
 shrubs ..... 40, 42, 46–47  
 skunk cabbage ..... 41  
 small plants ..... 43  
 small trees ..... 42–43  
 soft rushes ..... 41  
 soil ..... vi, 3, 7, 9, 18, 22–23, 26,  
   28, 37, 40–41  
   soil amendment ..... 7, 10  
   soil testing ..... 28–29  
 spirea ..... 41  
 spreading manure ..... 7  
 stall waste ..... 6, 8, 11  
 starlings ..... 47  
 stock tank ..... 40, 46  
 stock watering tanks ..... 21  
 stream(s) ..... vi–vii, 3, 6, 18–19,  
   21–23, 28–29, 39–41, 46–47  
 stump grindings ..... 20  
 swales ..... 21  
 swallow ..... 45  
 swamps ..... 40

**T**

tamping rod ..... 6  
 tape measurer ..... 6  
 tarp ..... 3, 6–7, 22  
 temporary fencing .... 26. *See also* fencing  
 tools ..... 27  
 topsoil ..... vi, 8, 12, 18, 23  
 toxic ..... 22, 29  
   toxic plants, weeds ..... 29  
 tractor ..... 5, 7, 9, 19, 27–28  
 traps ..... 48  
 treated boards ..... 6  
 treated posts ..... 6  
 trees ..... 22, 24, 27, 40, 42, 46, 48  
 troubleshooting ..... 7  
 trout ..... 18  
 truck ..... 27  
 turnout area ..... 24

**U**

urea ..... 4, 8  
 urine ..... 2, 19, 40  
 utility trailer ..... 27

**V**

vegetation ..... 3, 40–41, 46  
 viruses ..... 5

**W**

wasps ..... 48  
 water ..... v–vi, 3, 5, 7, 18, 20, 22, 23,  
   25–27, 39, 41, 46–47  
   water bars ..... 21  
   water crossings ..... 21  
   water table ..... 41  
   watering point ..... 21, 40  
 watershed ..... 40  
 weed(s), weed seeds .... vi, 4–6, 9–10, 23,  
   25, 27, 29, 37  
 well(s) ..... 40, 41  
 wetland(s) ..... vi–vii, 3, 6, 21–22, 24,  
   28–29, 40–41, 46–47  
 wheelbarrow ..... 5, 25  
 wildlife ..... v, 22, 39, 42, 46–47  
 willow ..... 22  
 wood pellets ..... 2  
 worm ..... 1  
 worm eggs ..... 2, 4, 8, 10

**Y**

yellowjackets ..... 47, 48

